

Fußgängerüberweg

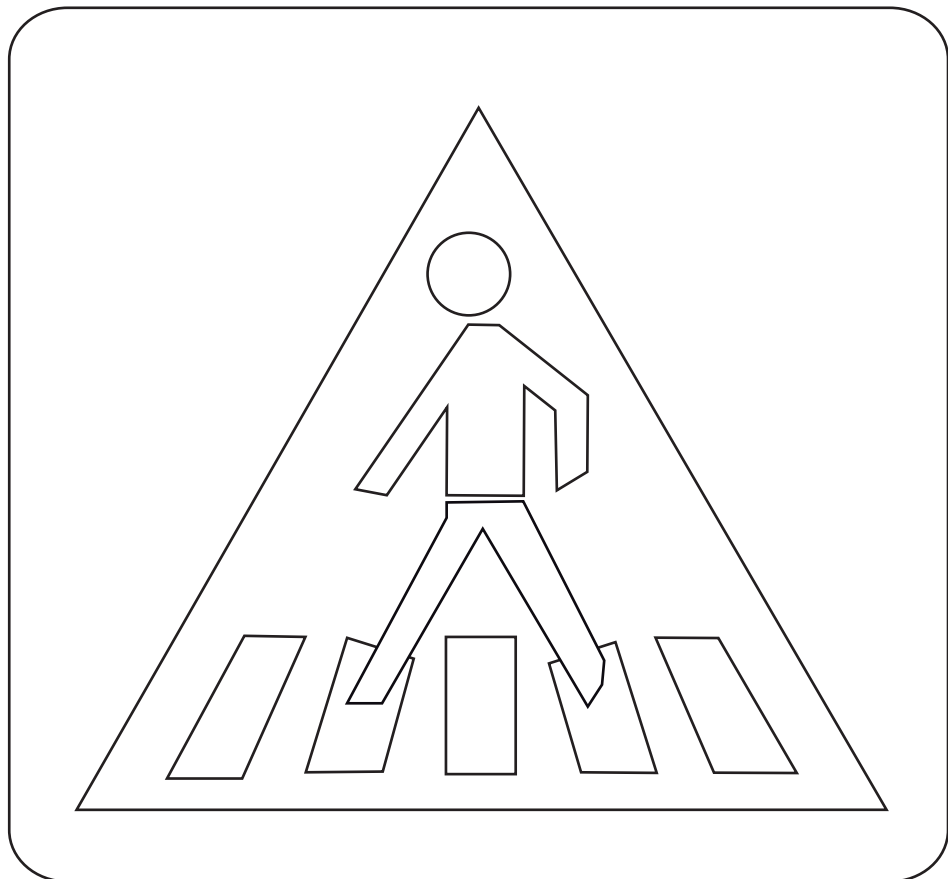

Gefahrenstelle

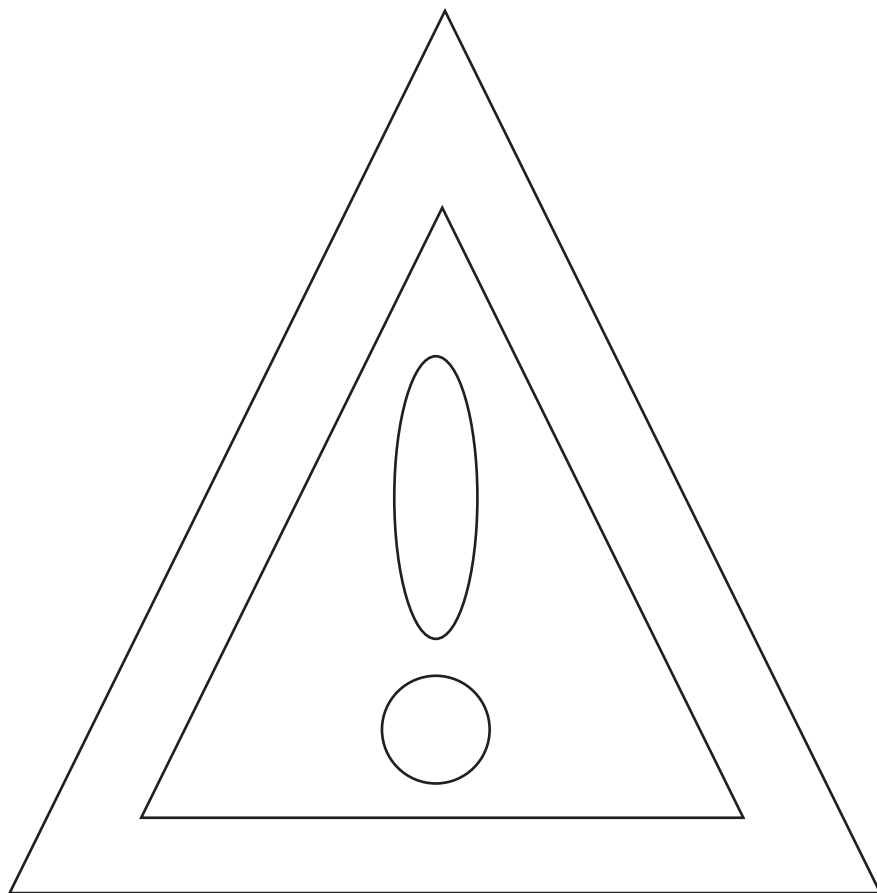

Stoppschild

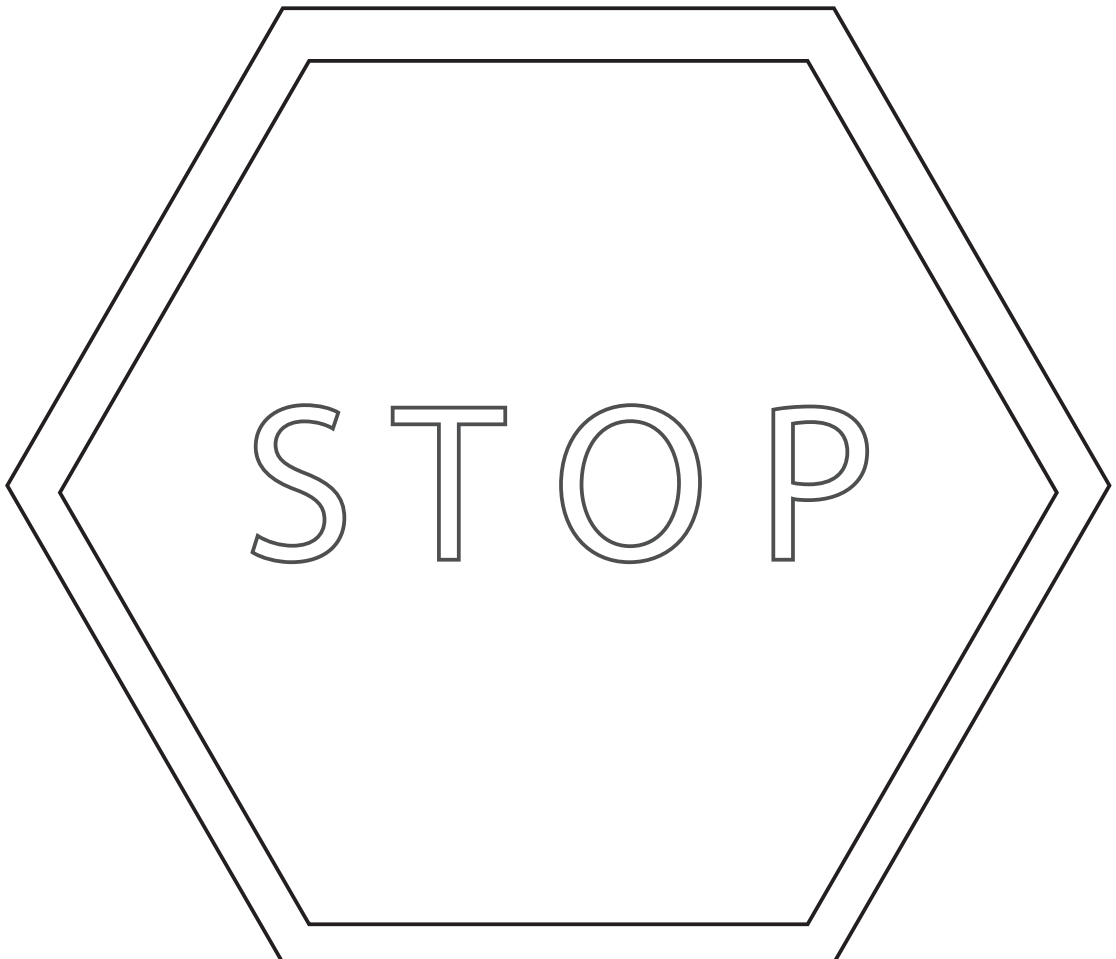

Fuß und Radweg

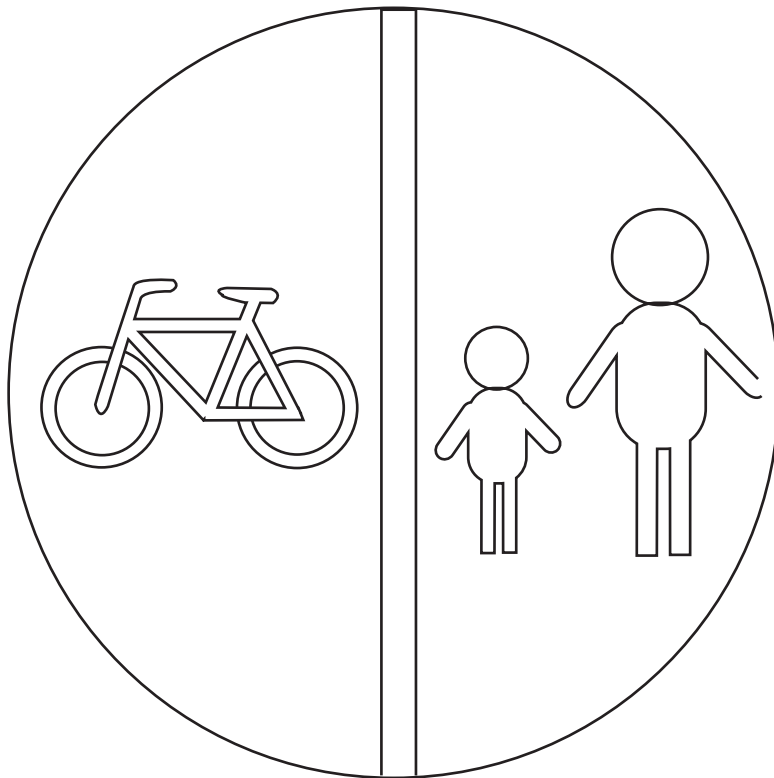

Radweg

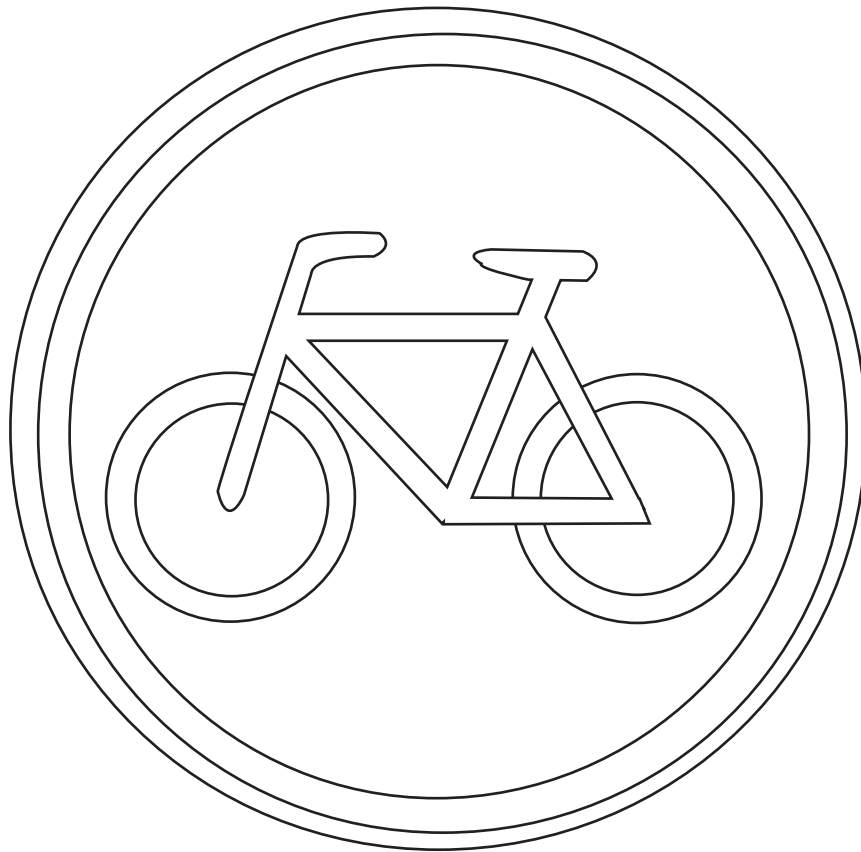

Ampel

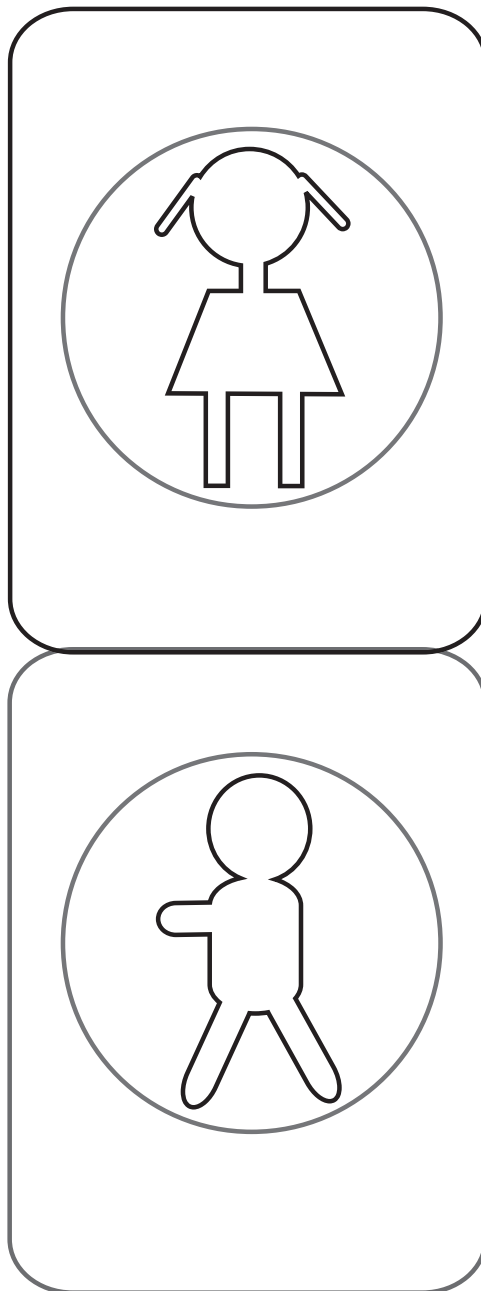
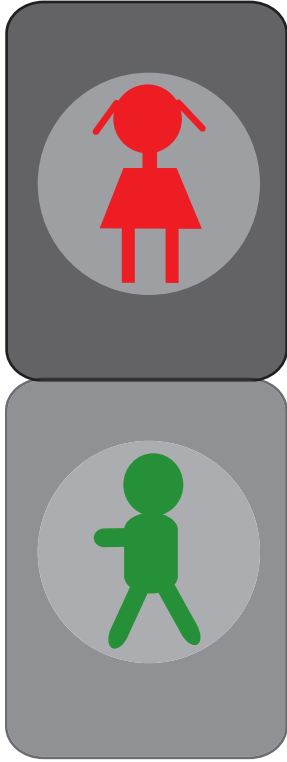

Fahrrad

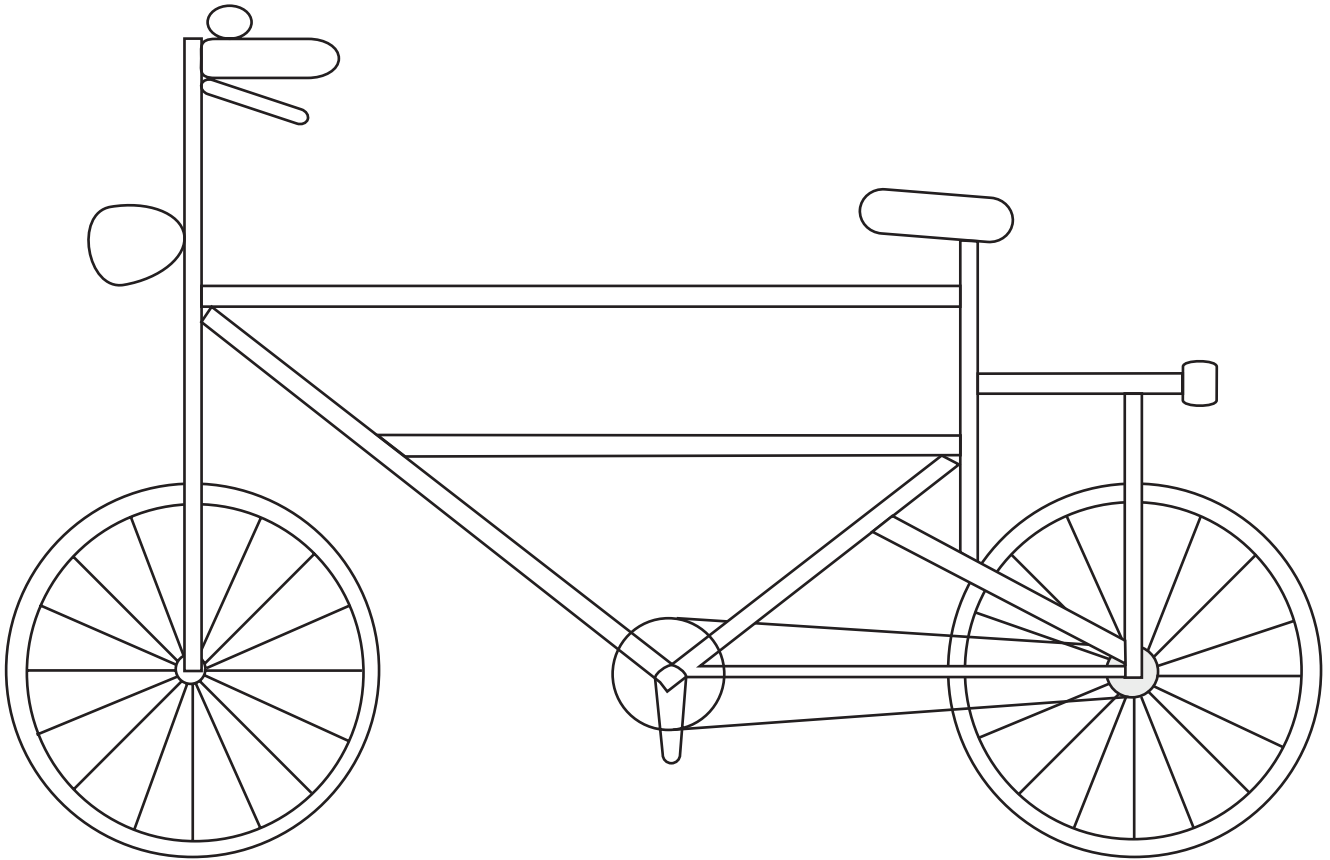
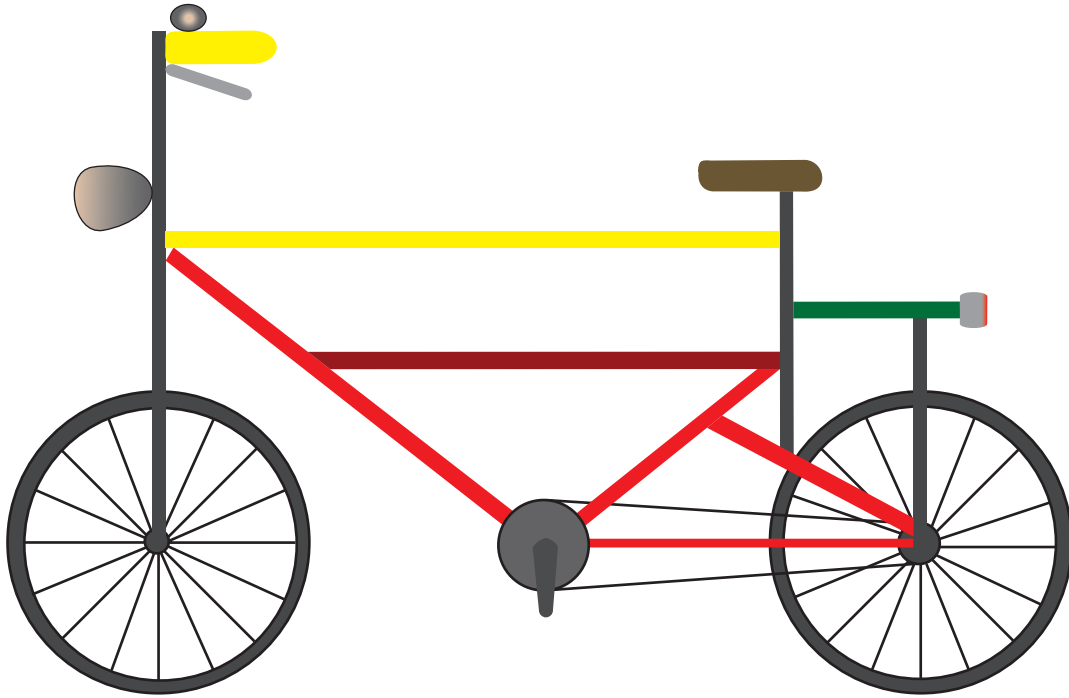

Spielstraße

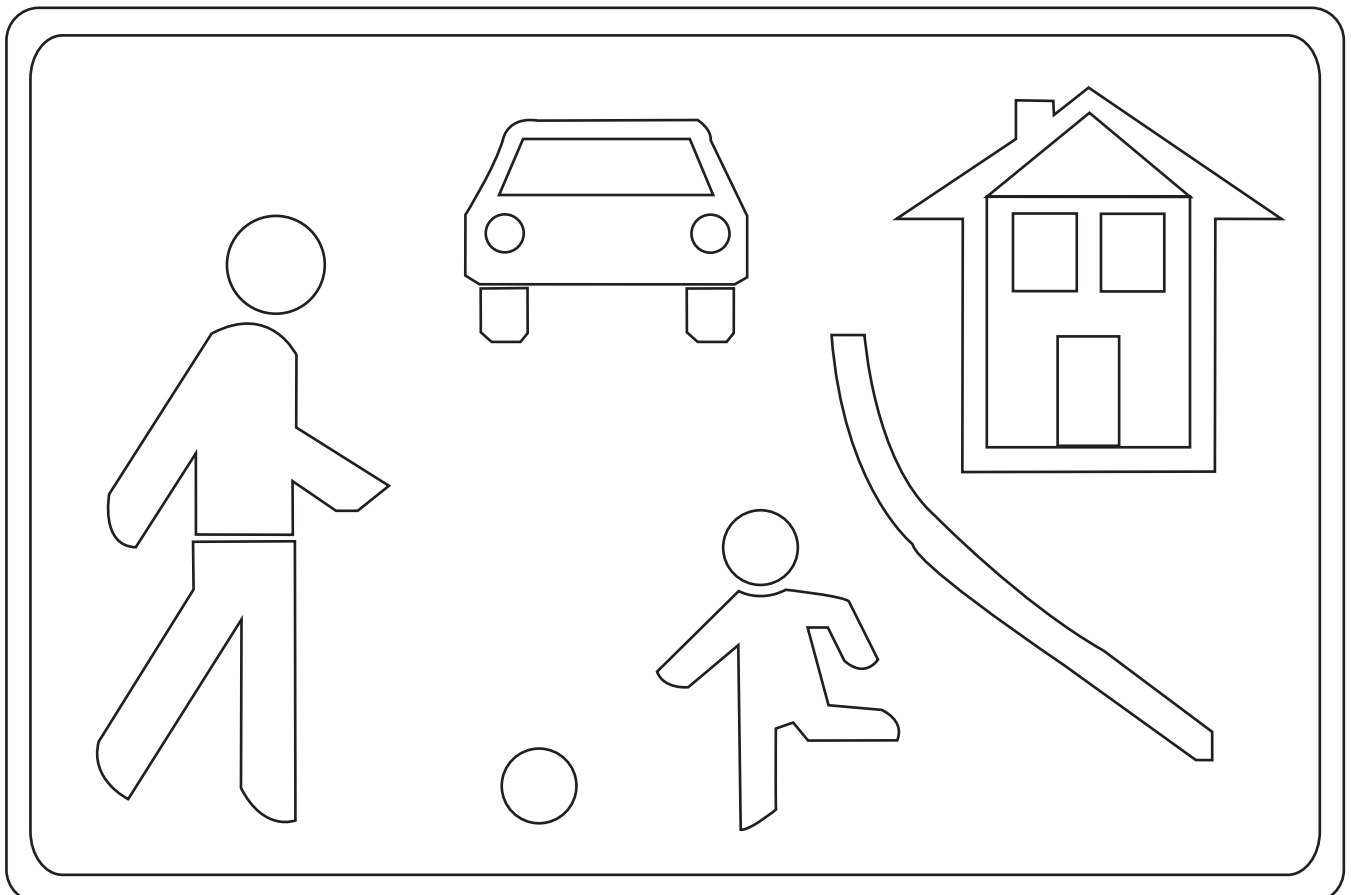
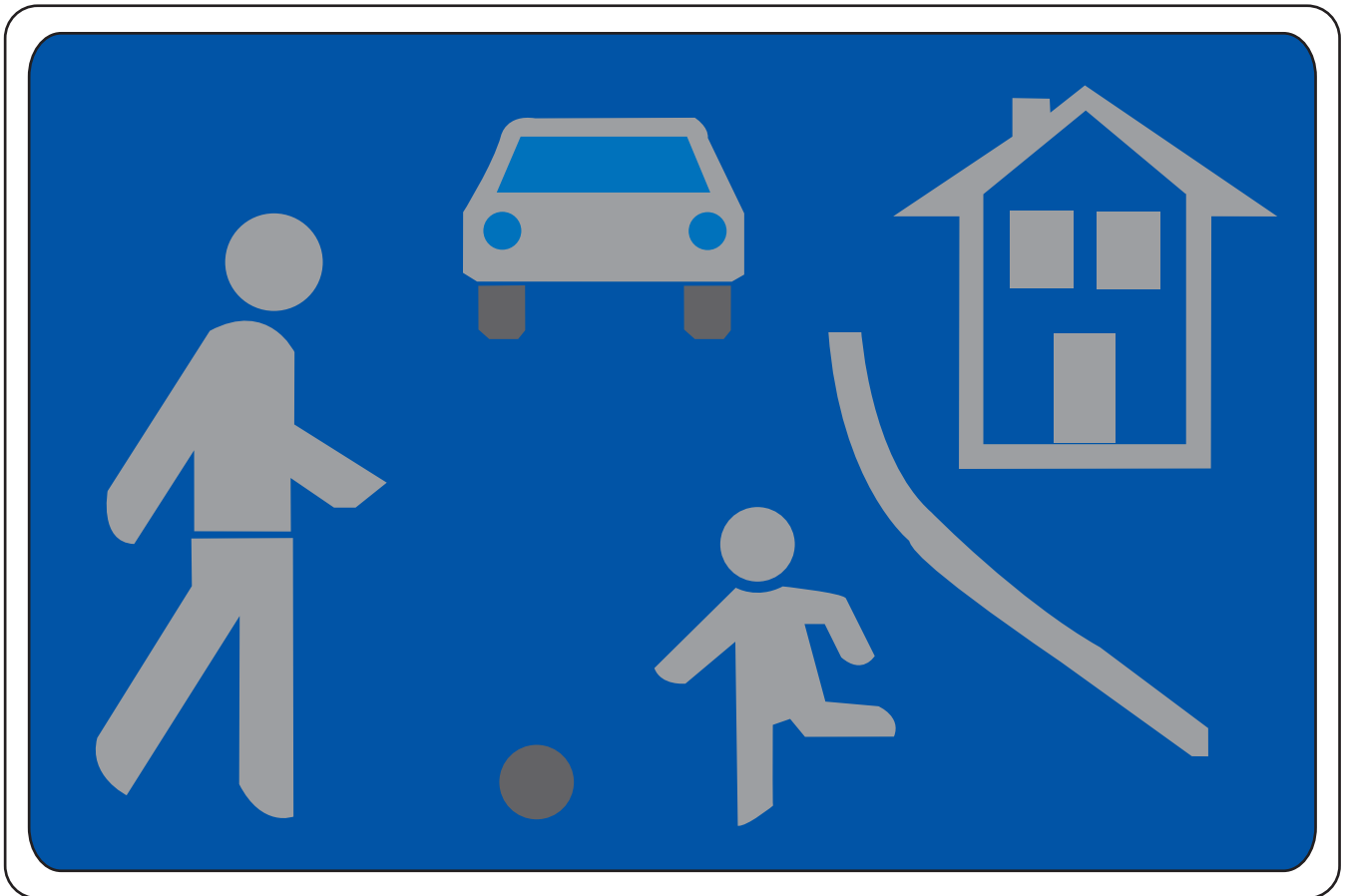

Haltestelle



Krankenhaus

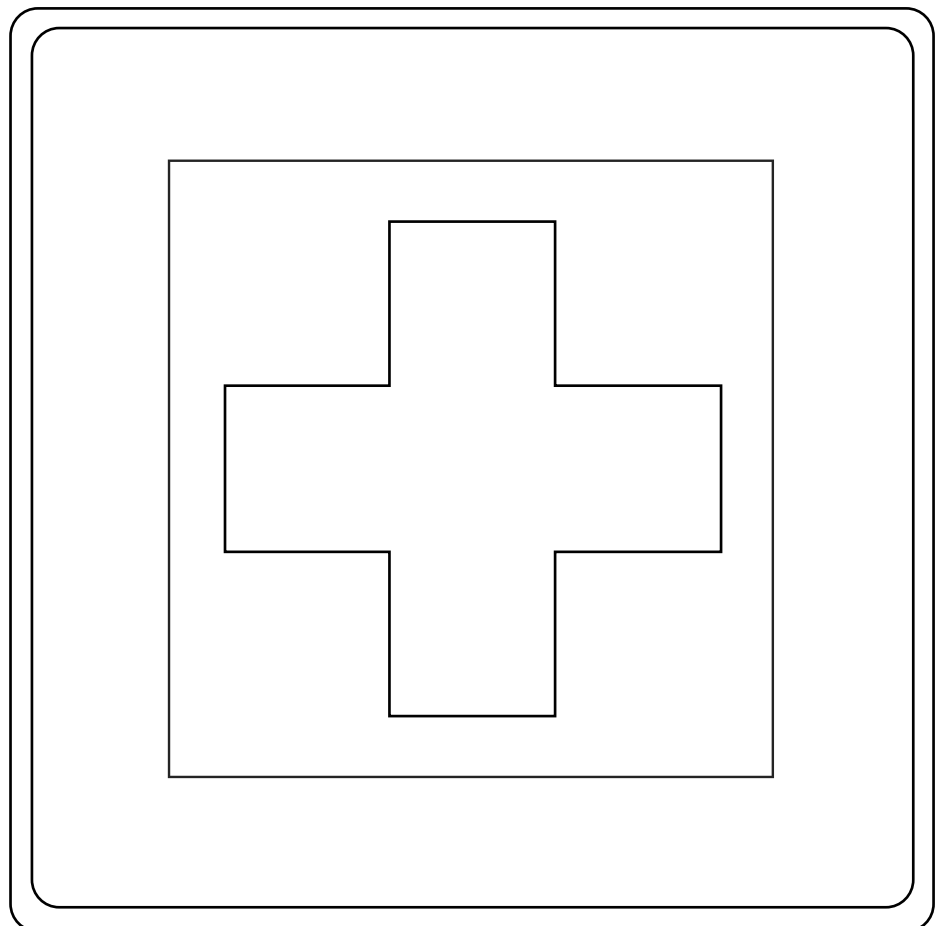
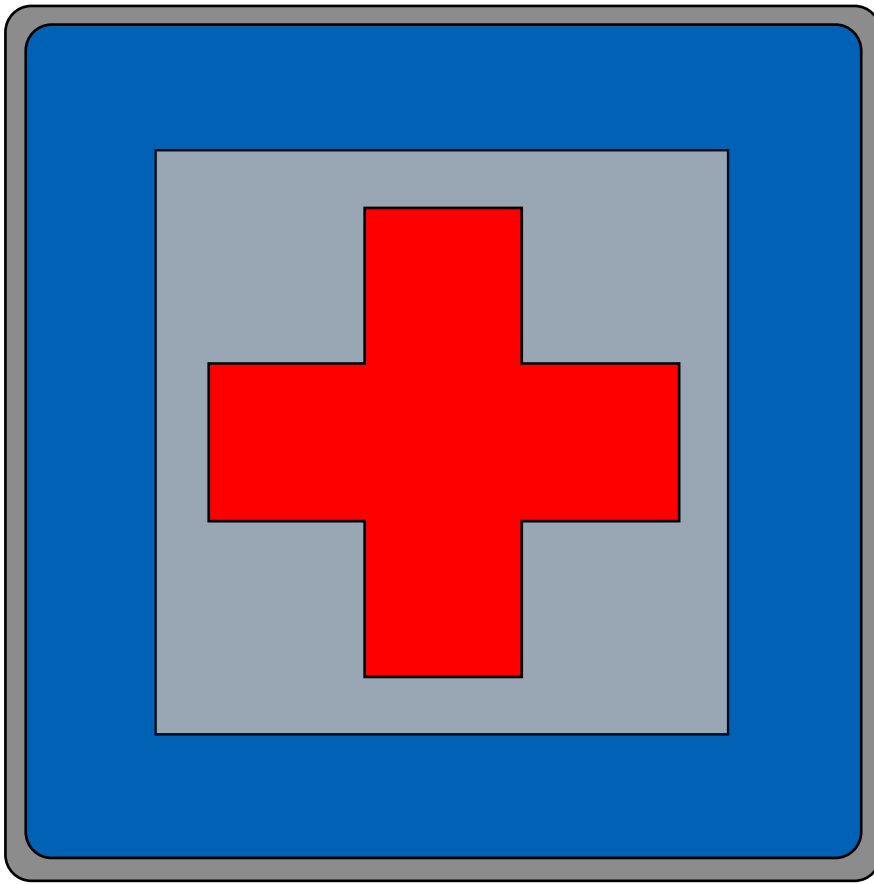

Krankenwagen

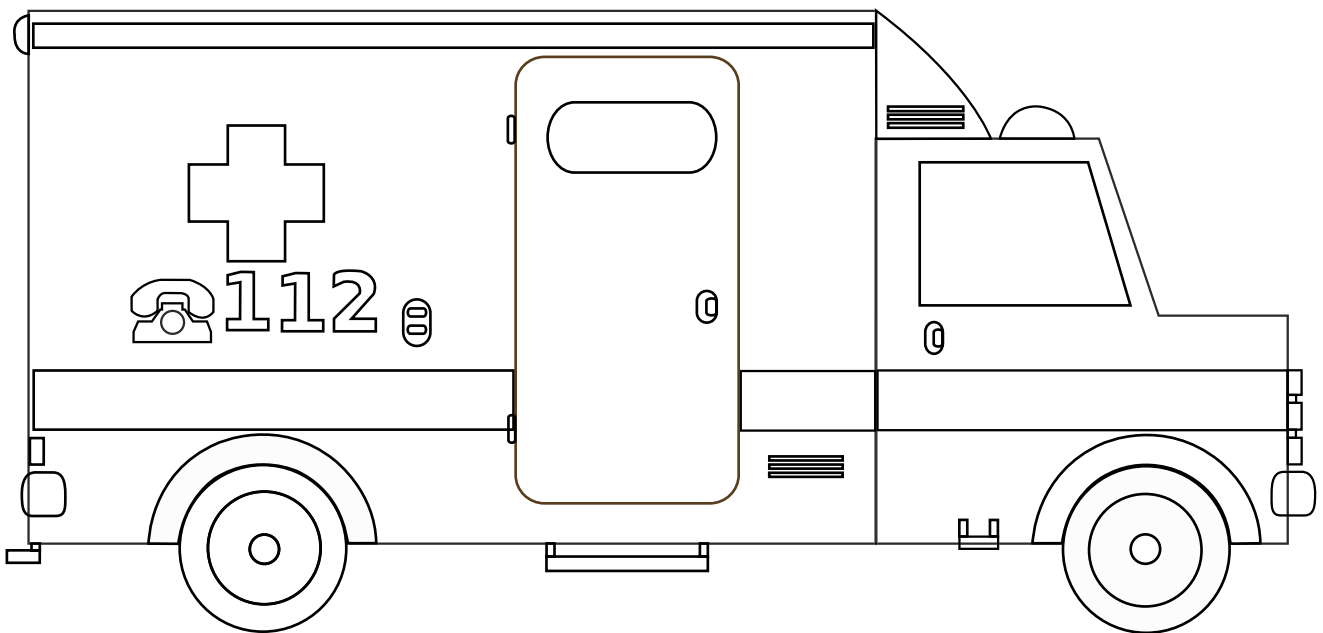
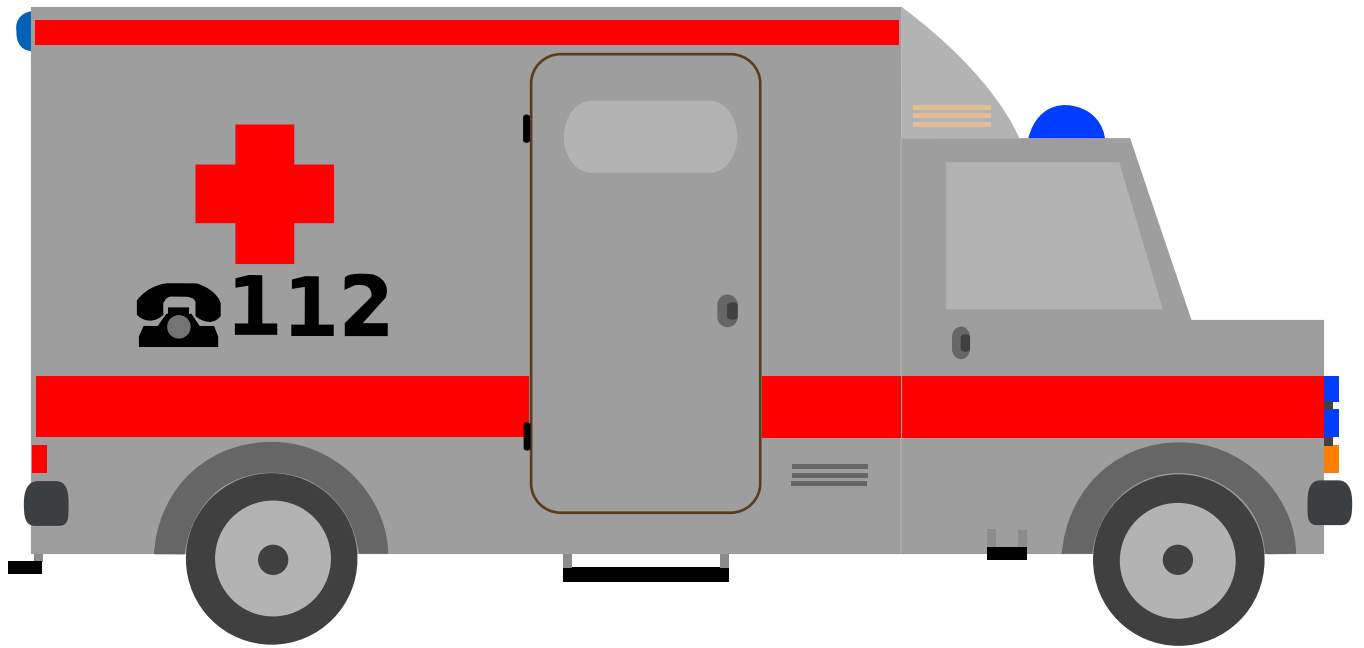

Busspur

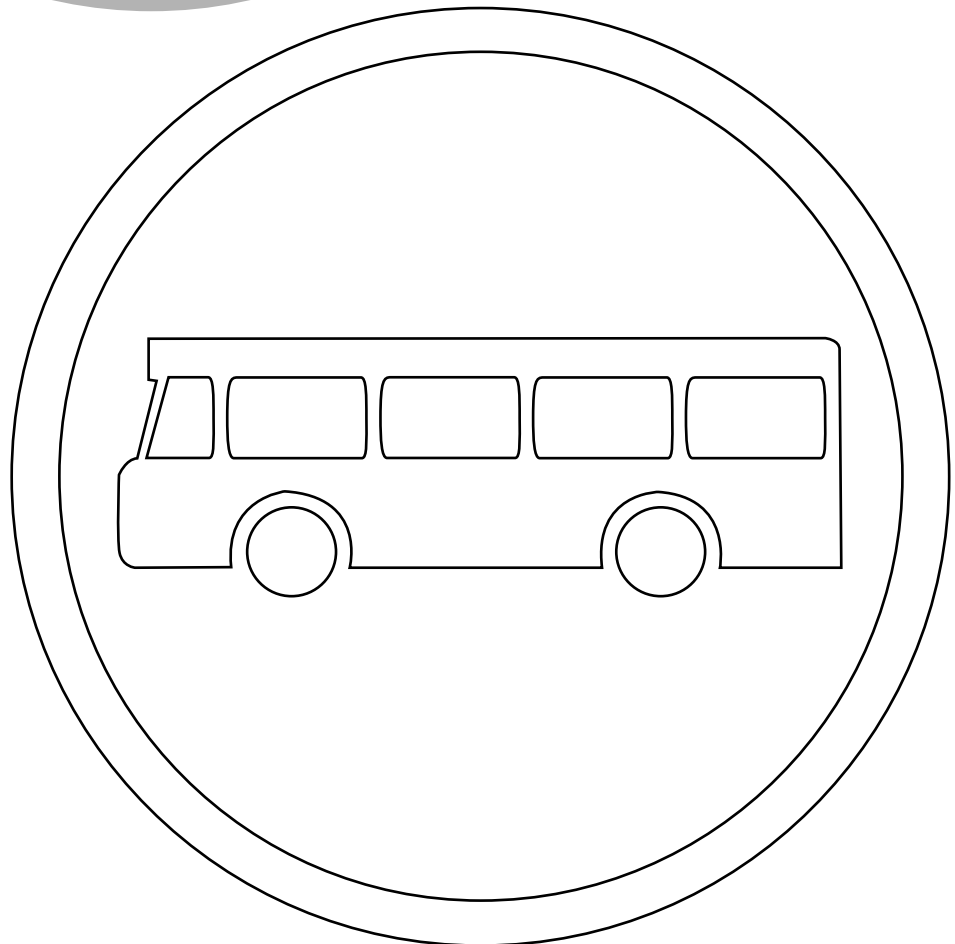
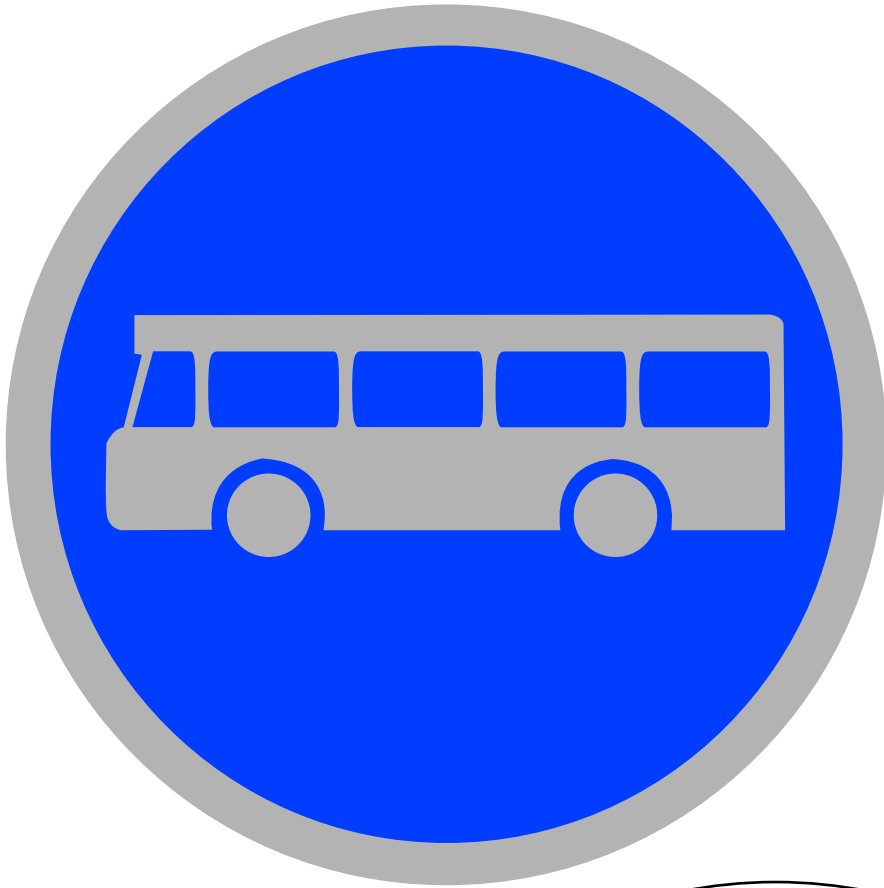

Bus

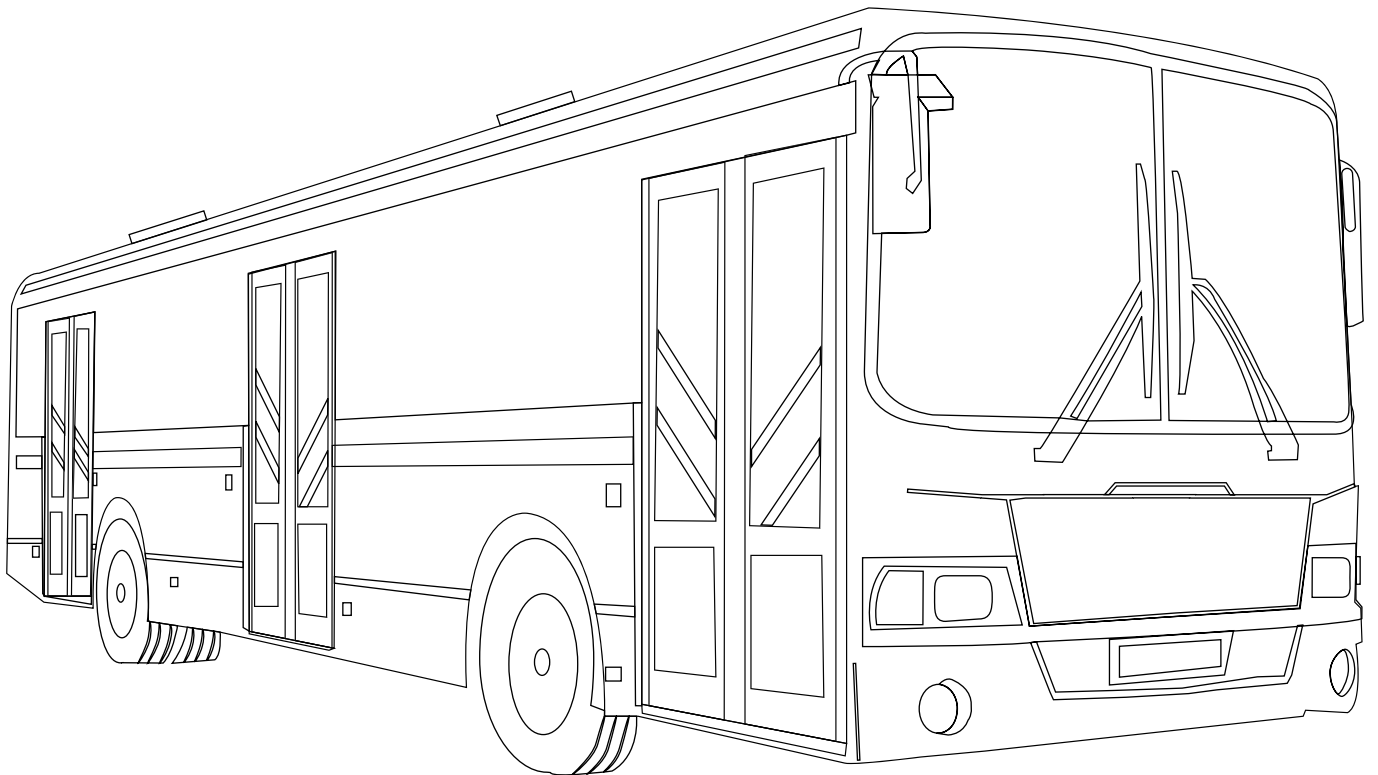

Bahnübergang

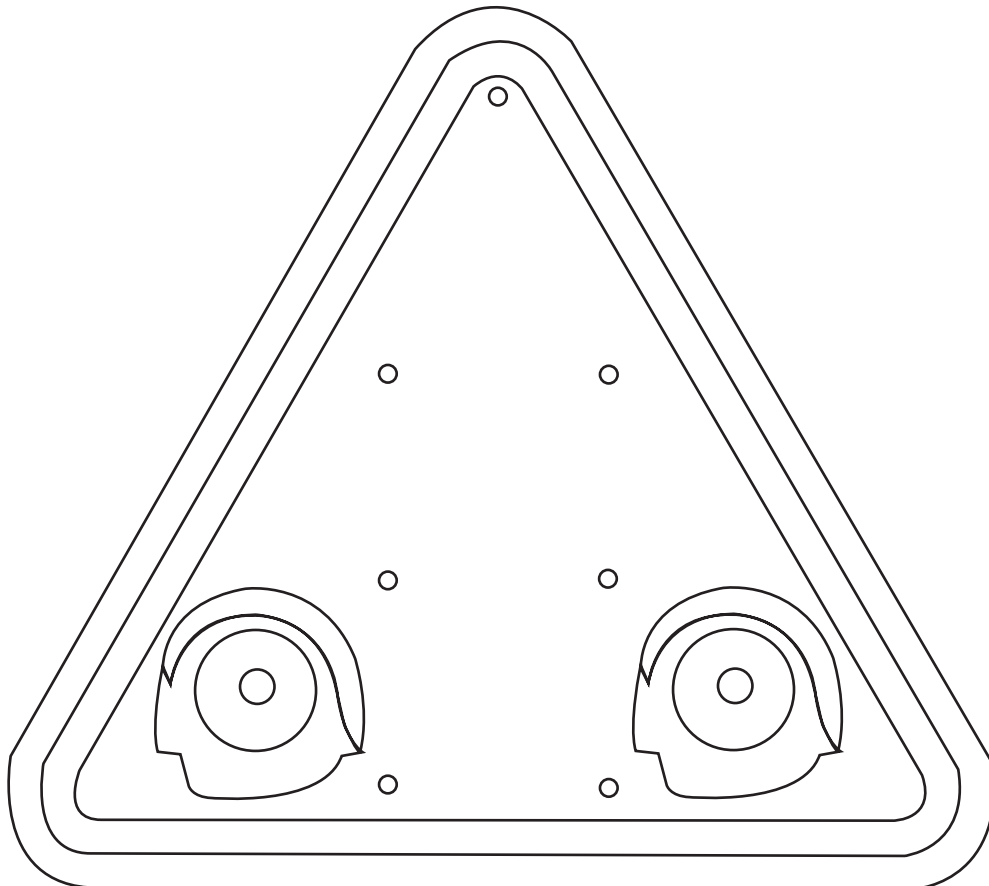

Unterführung



Ende Radweg



Sackgasse

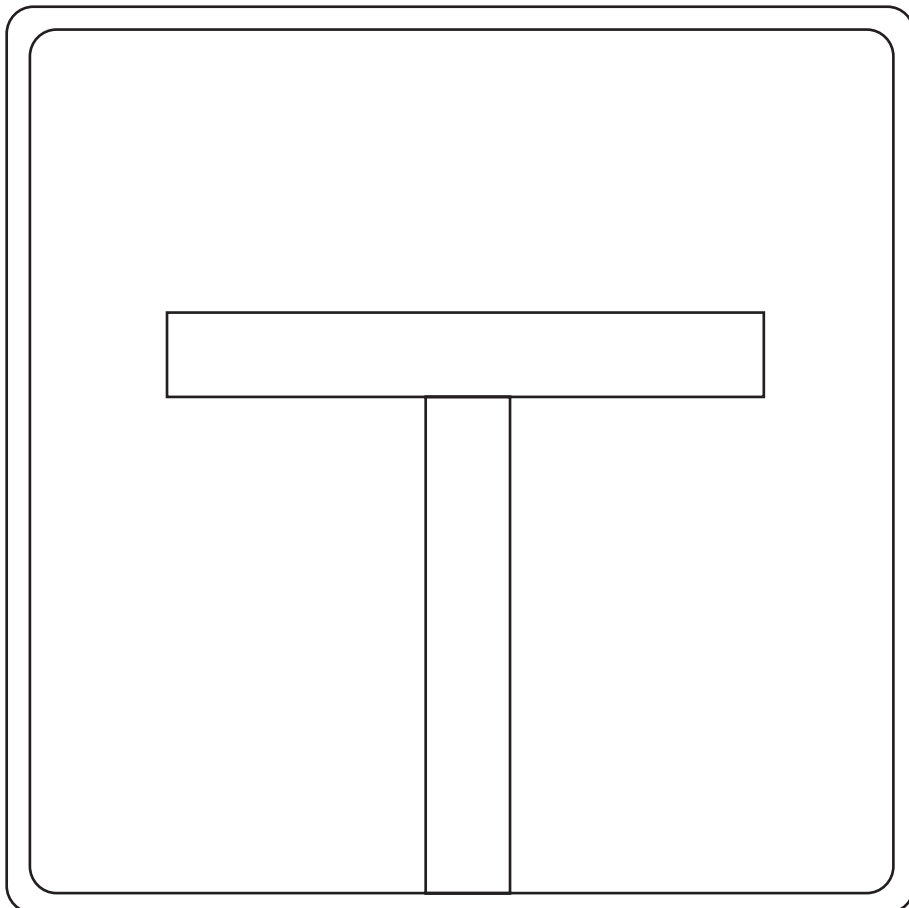

Einbahnstraße



Vorfahrt

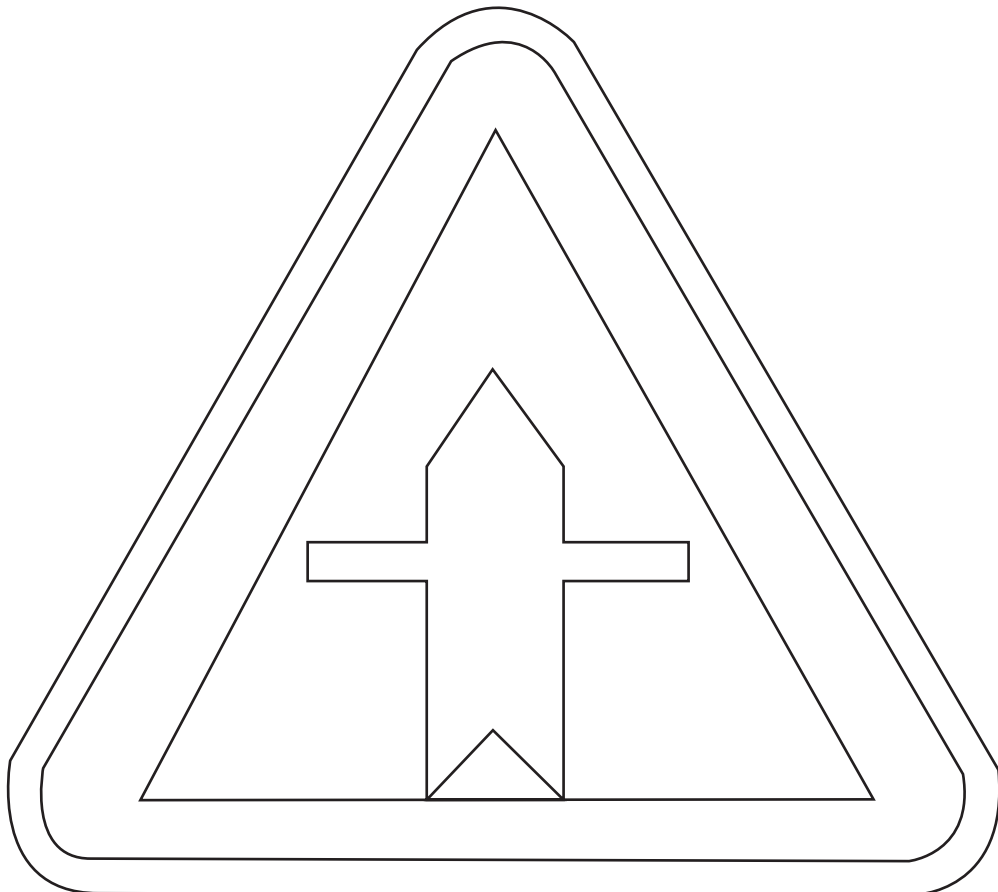

Polizeiwagen



Andreaskreuz Bake

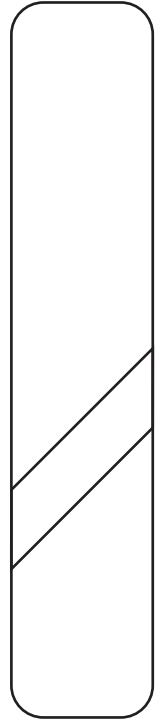
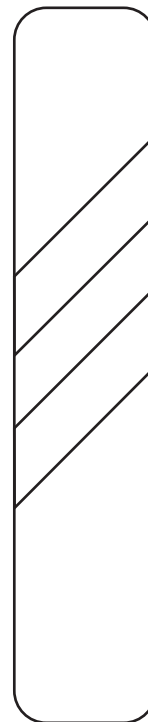
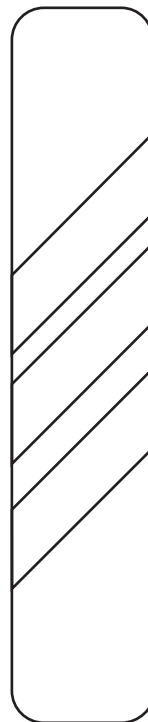
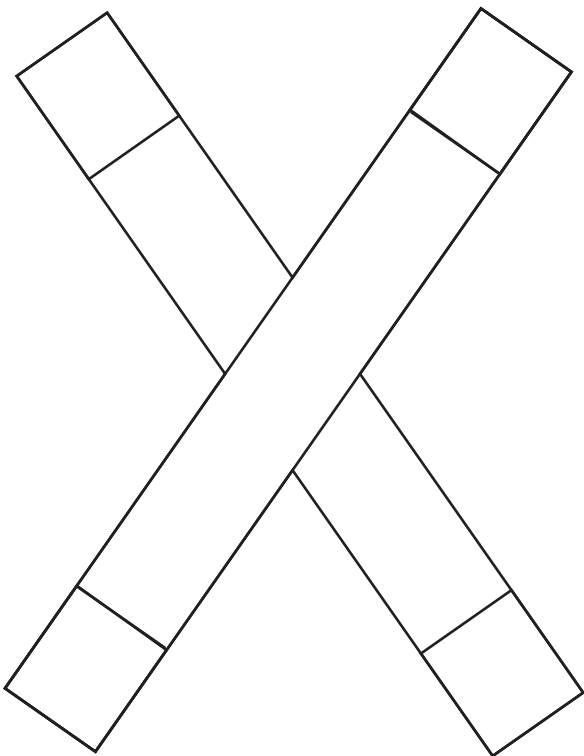
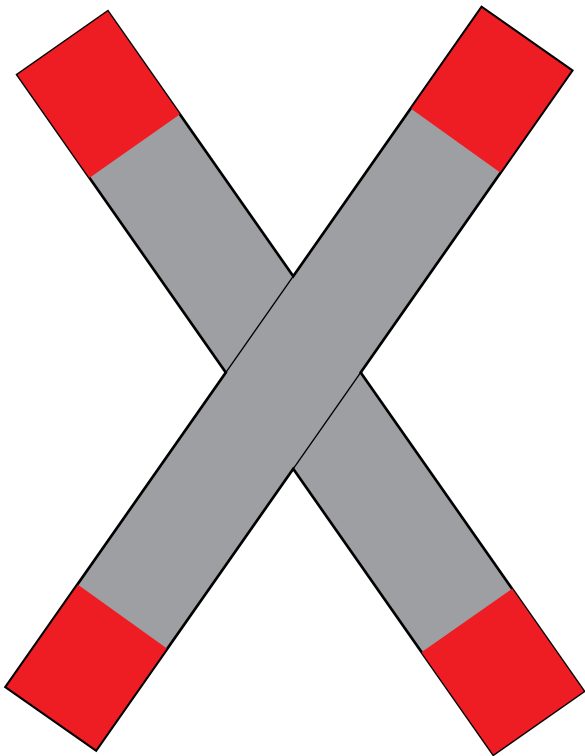

Baustelle

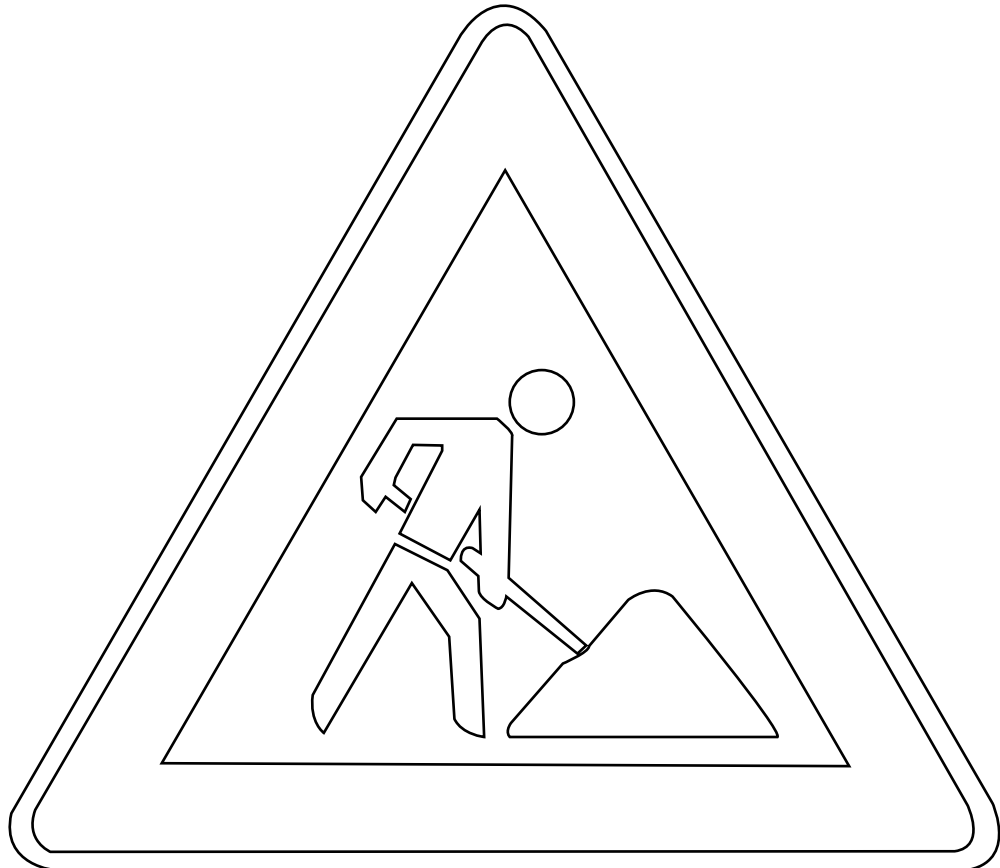

Höchstgeschwindigkeit

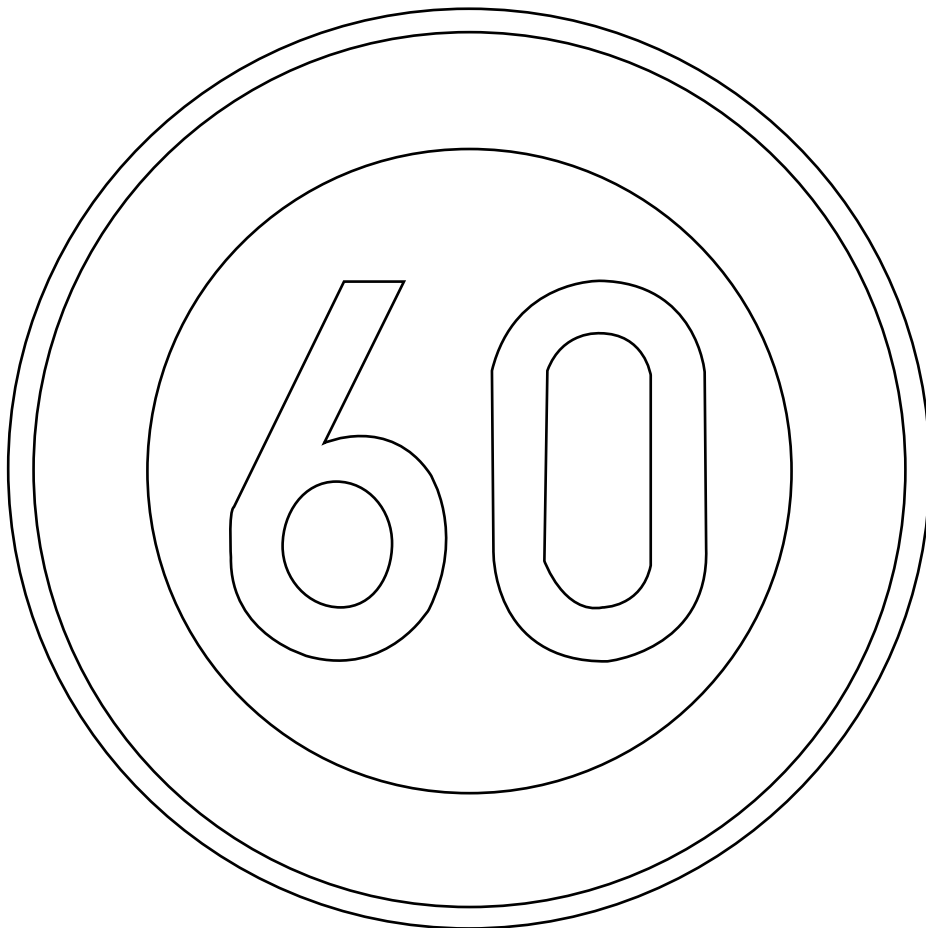

Kinder

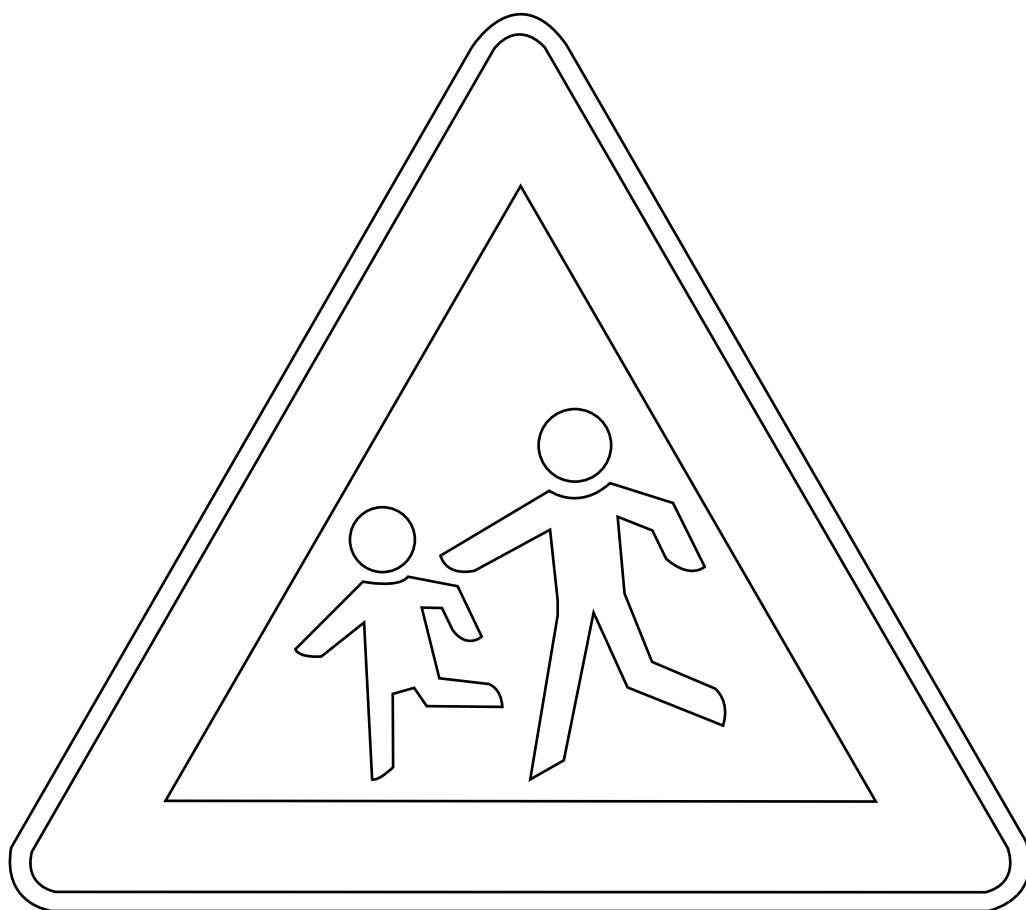

Wendeverbot

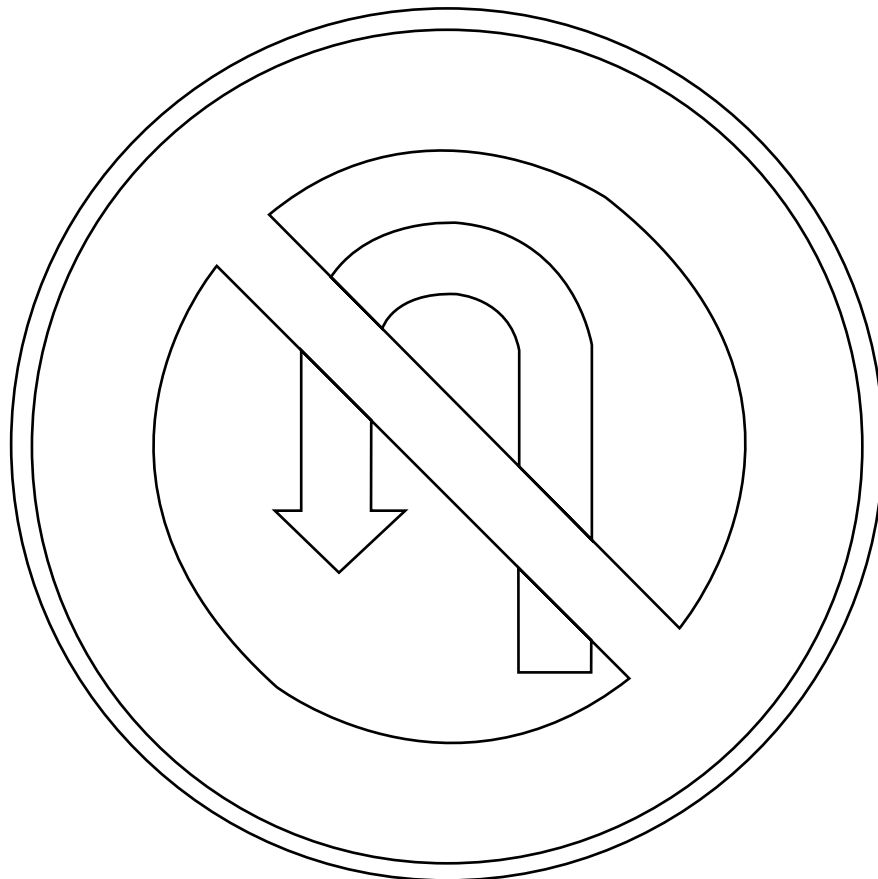

Halteverbot

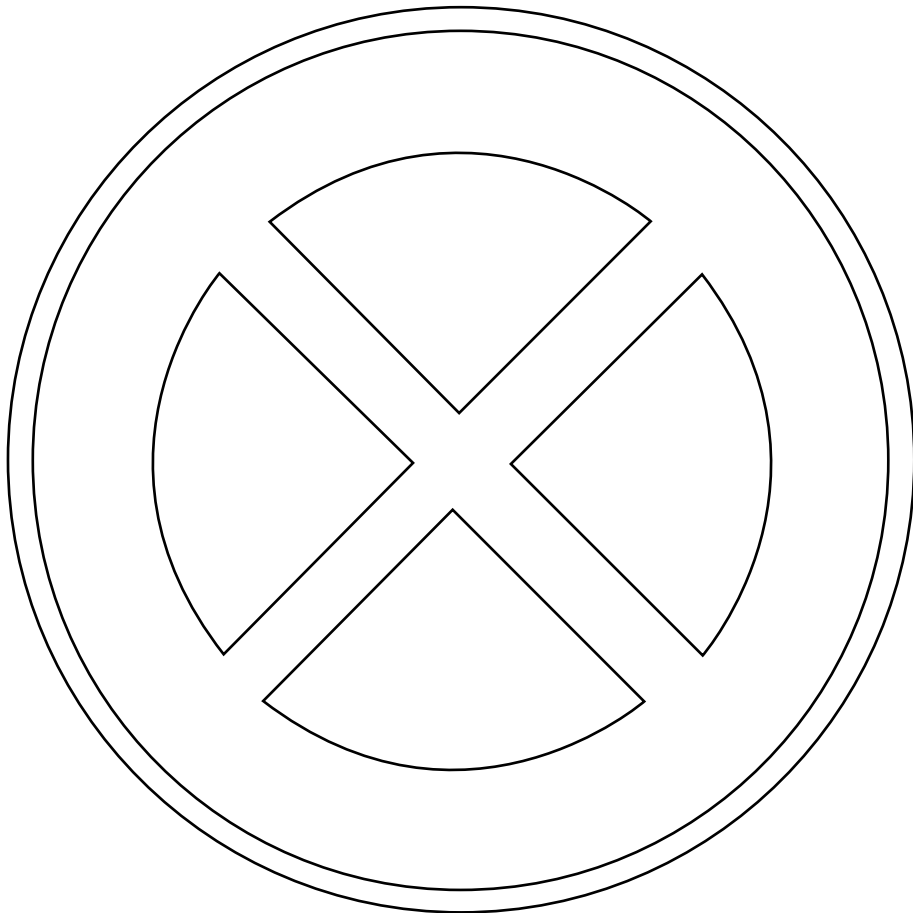
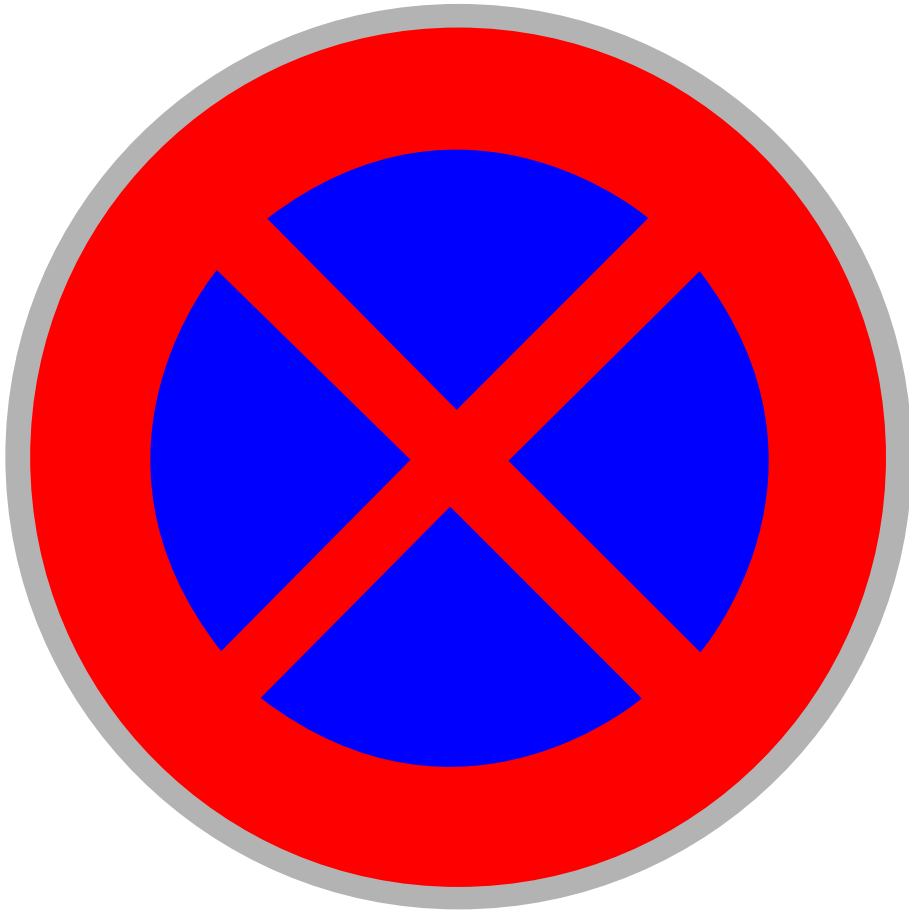

Parkverbot

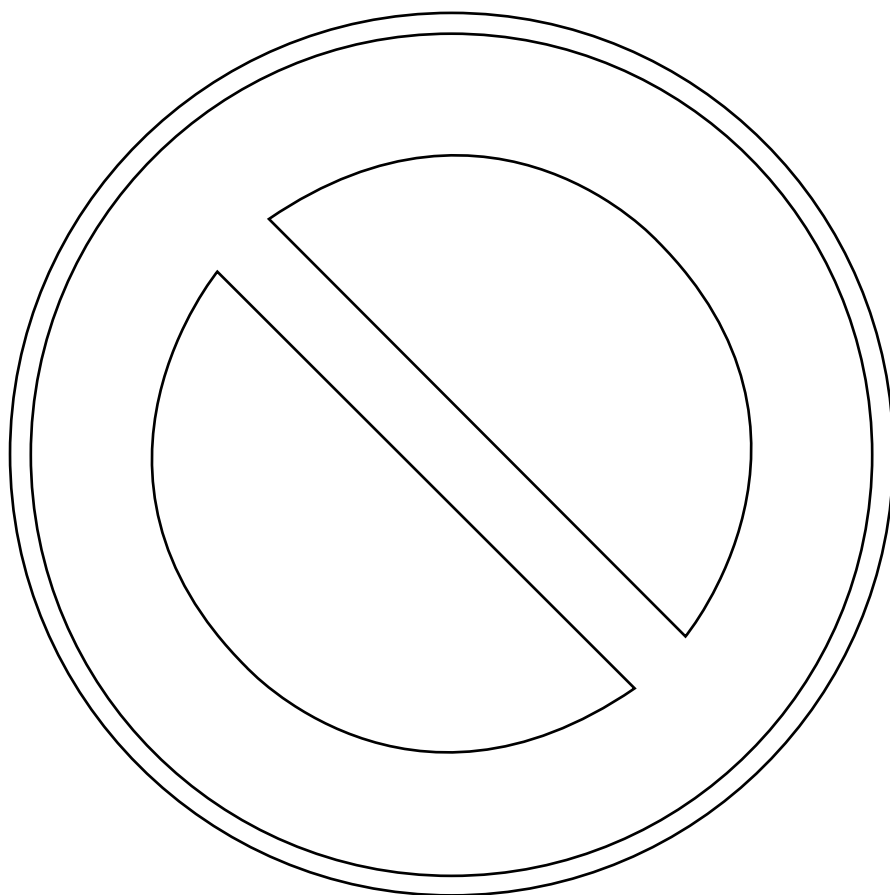

Ampelanlage

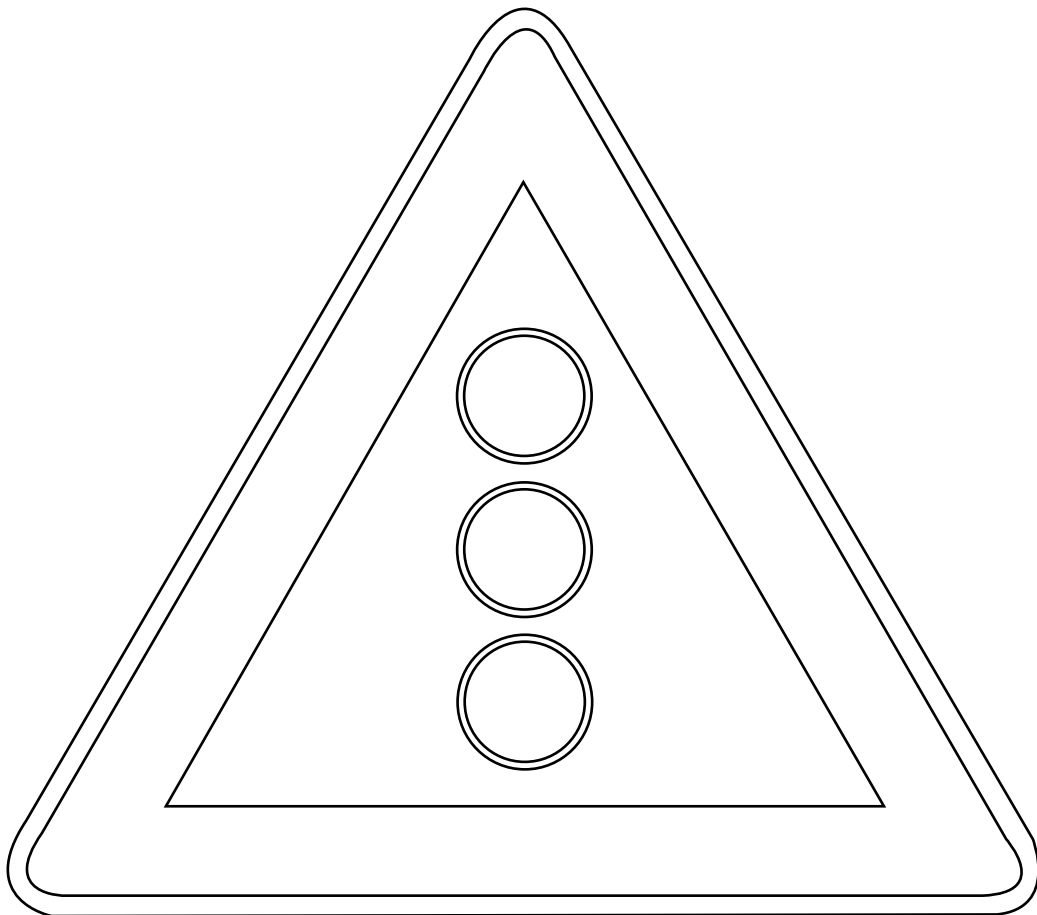

Einfahrverbot

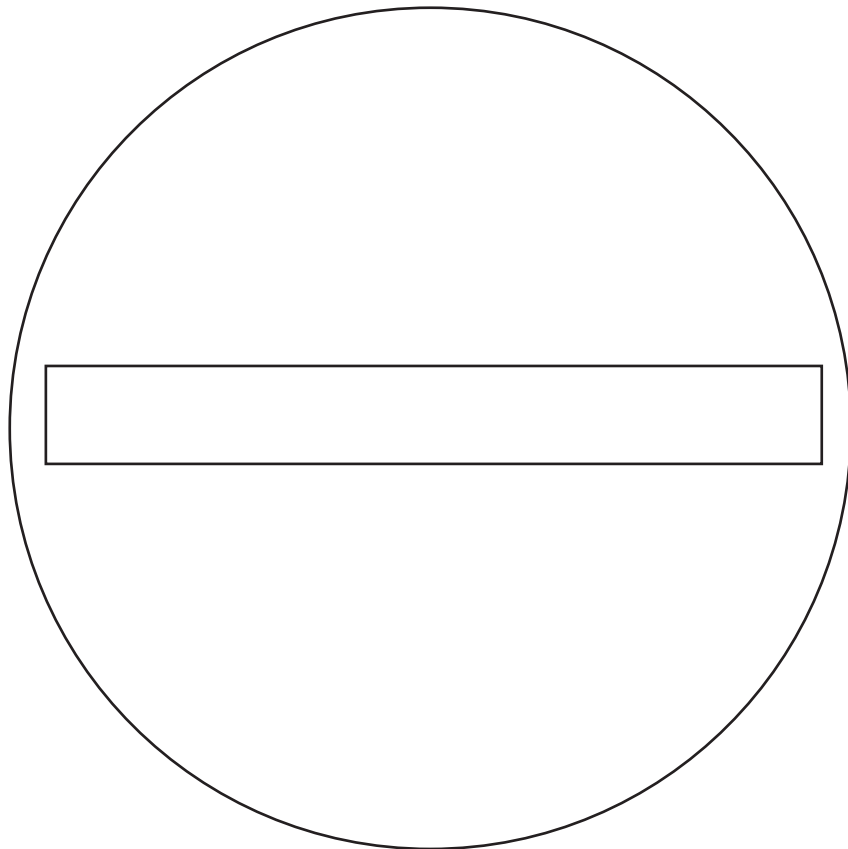
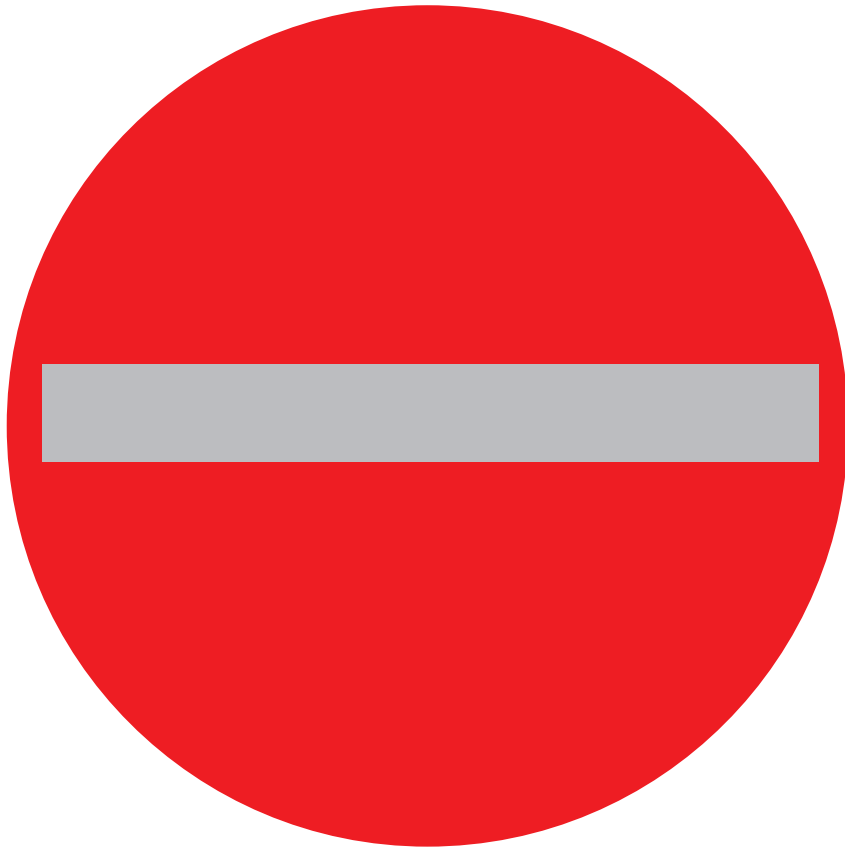

Vorfahrt gewähren

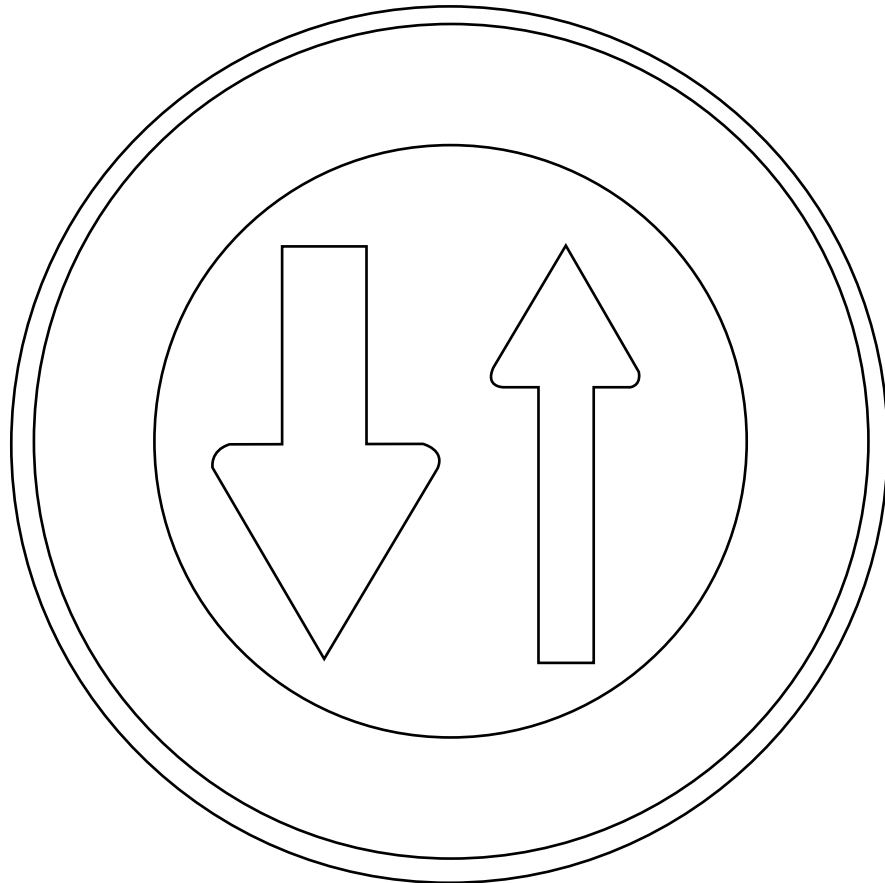
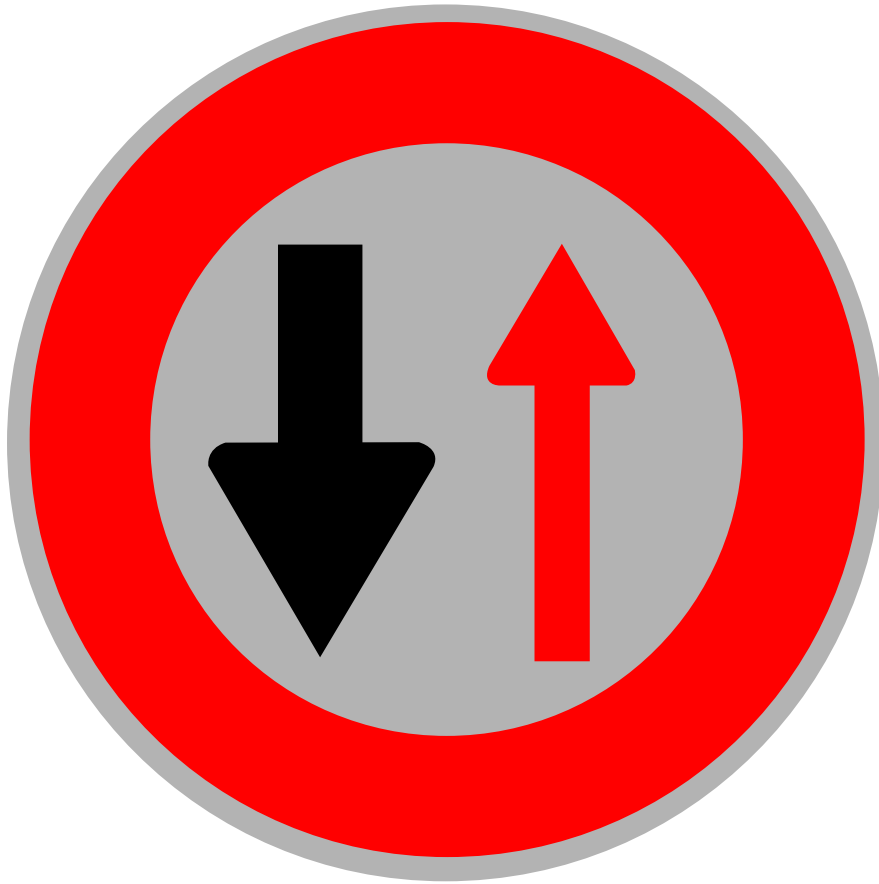

Gegenverkehr muß warten

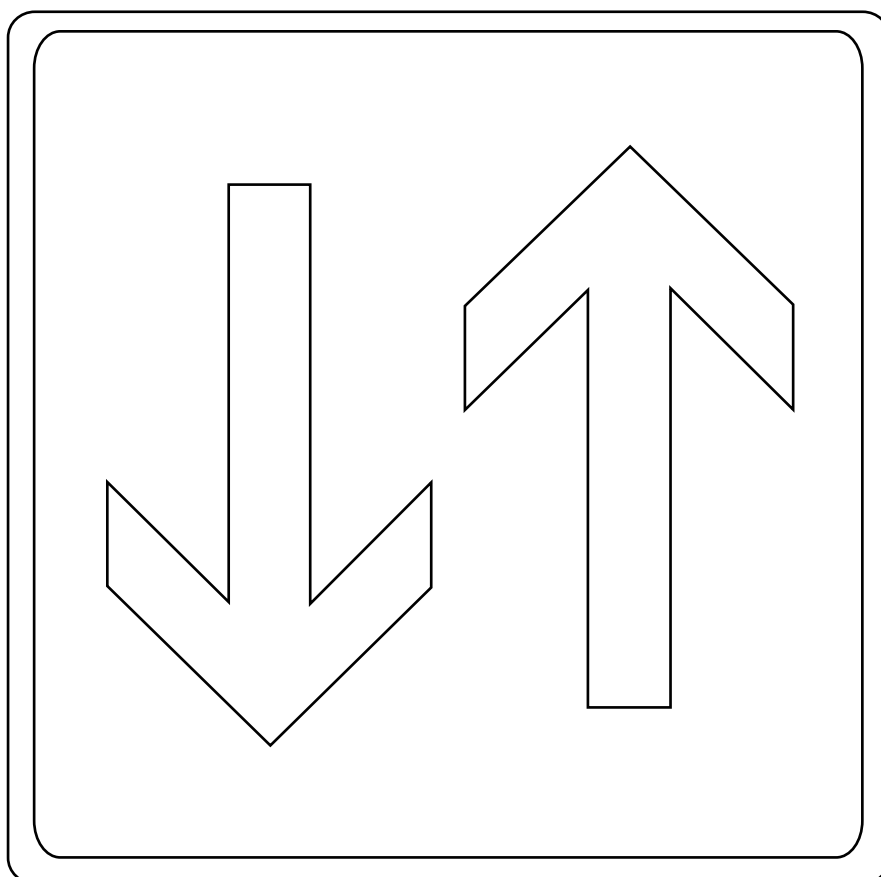
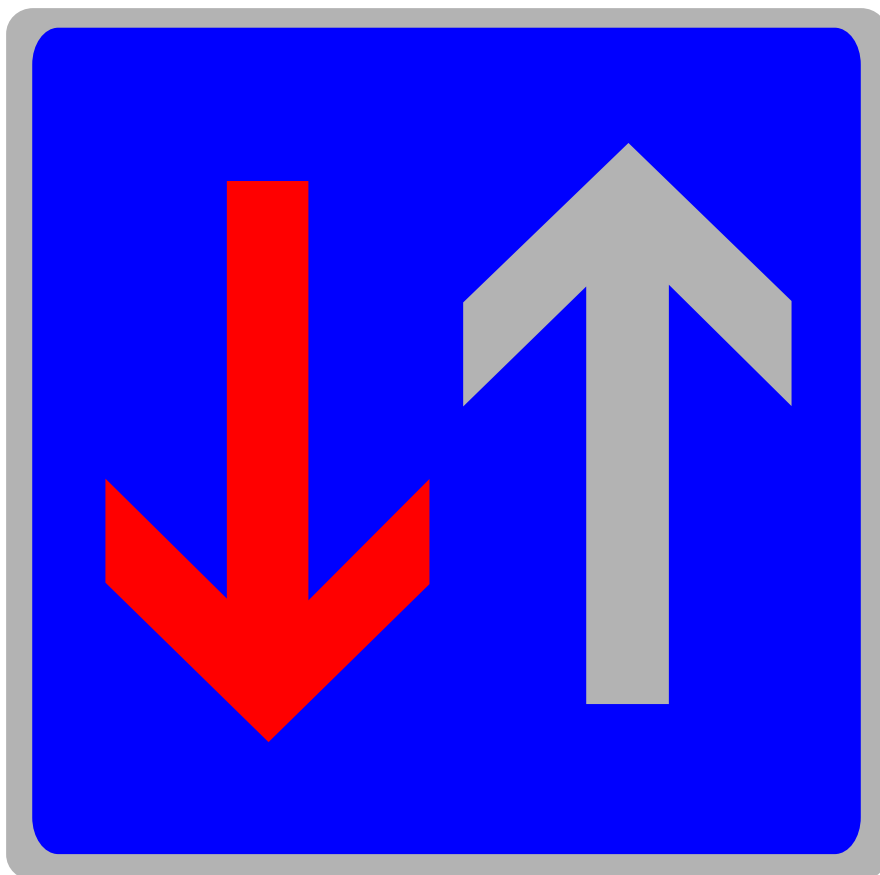

Kreisverkehr

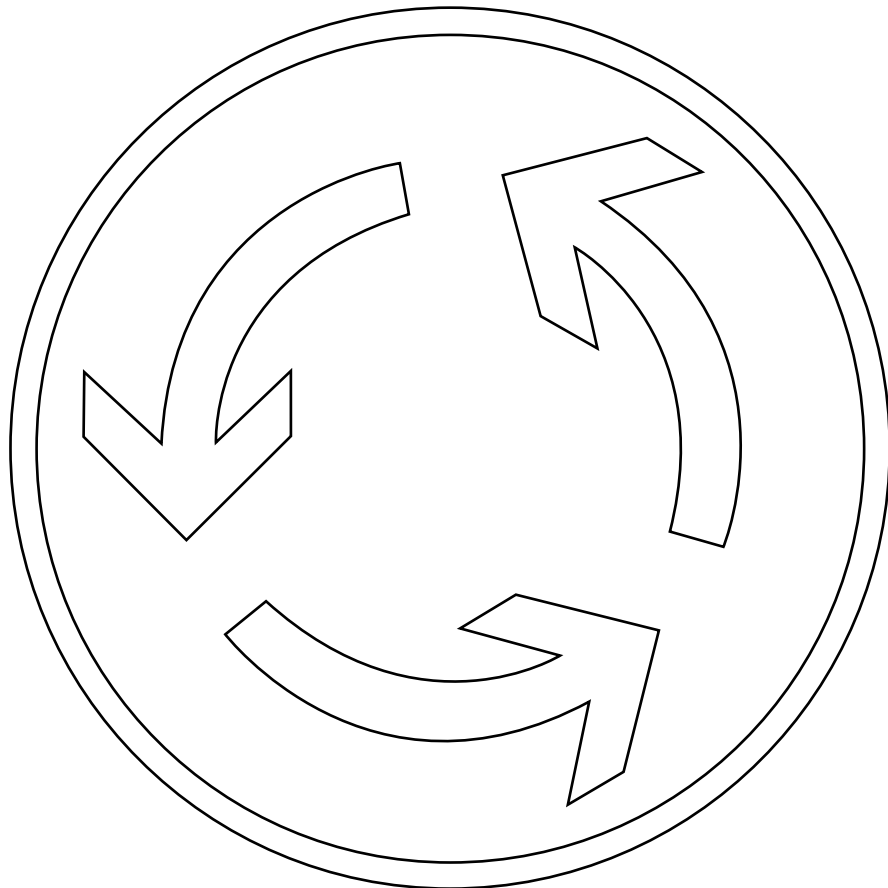

Hauptstraße

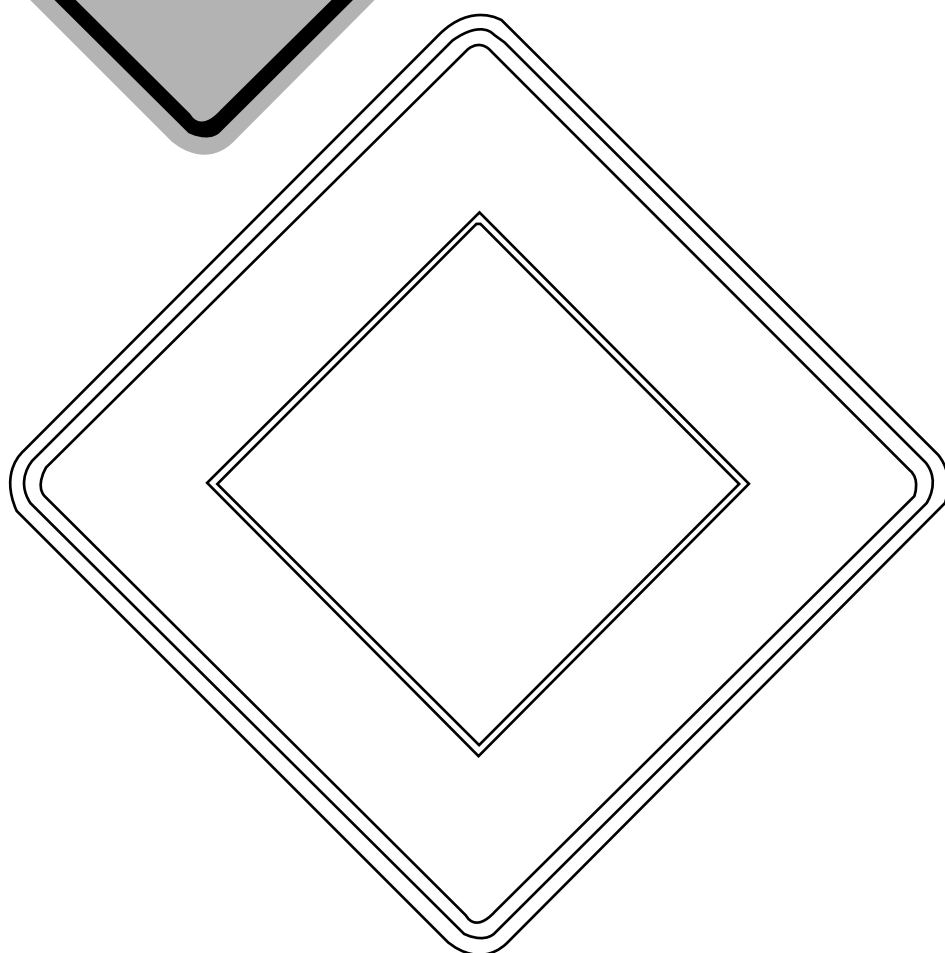
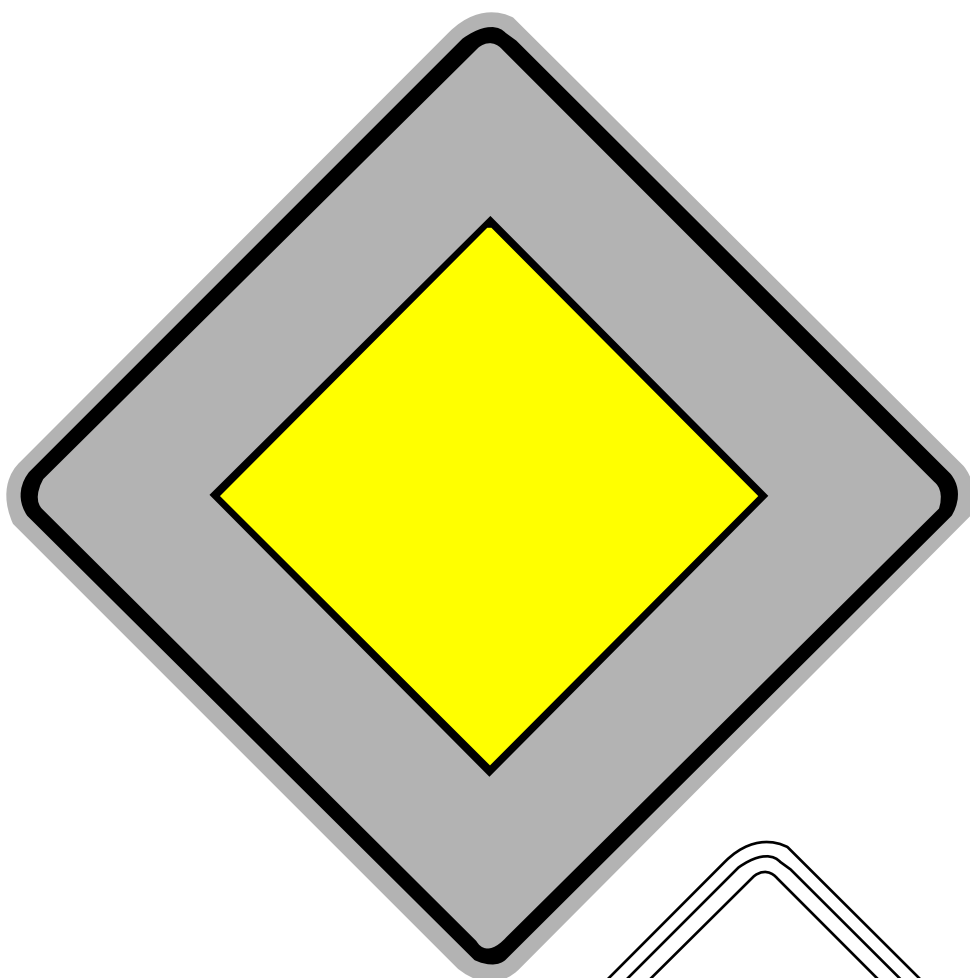

Frei für ---

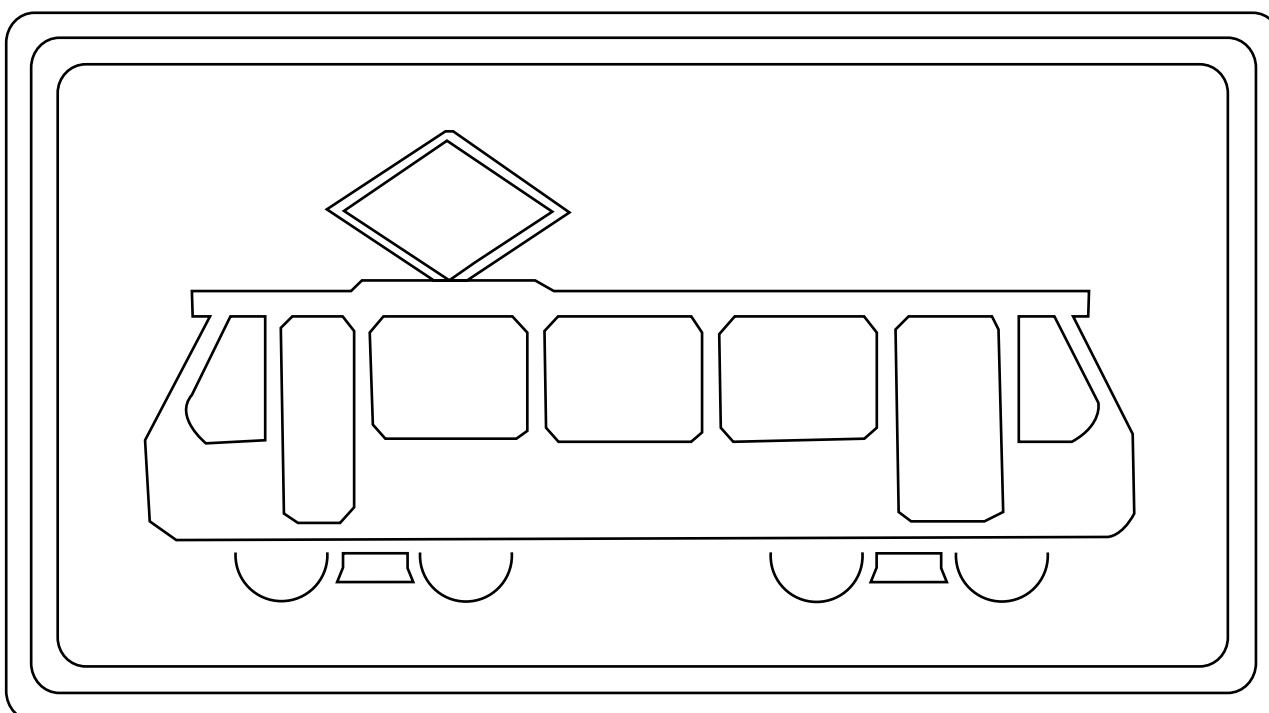
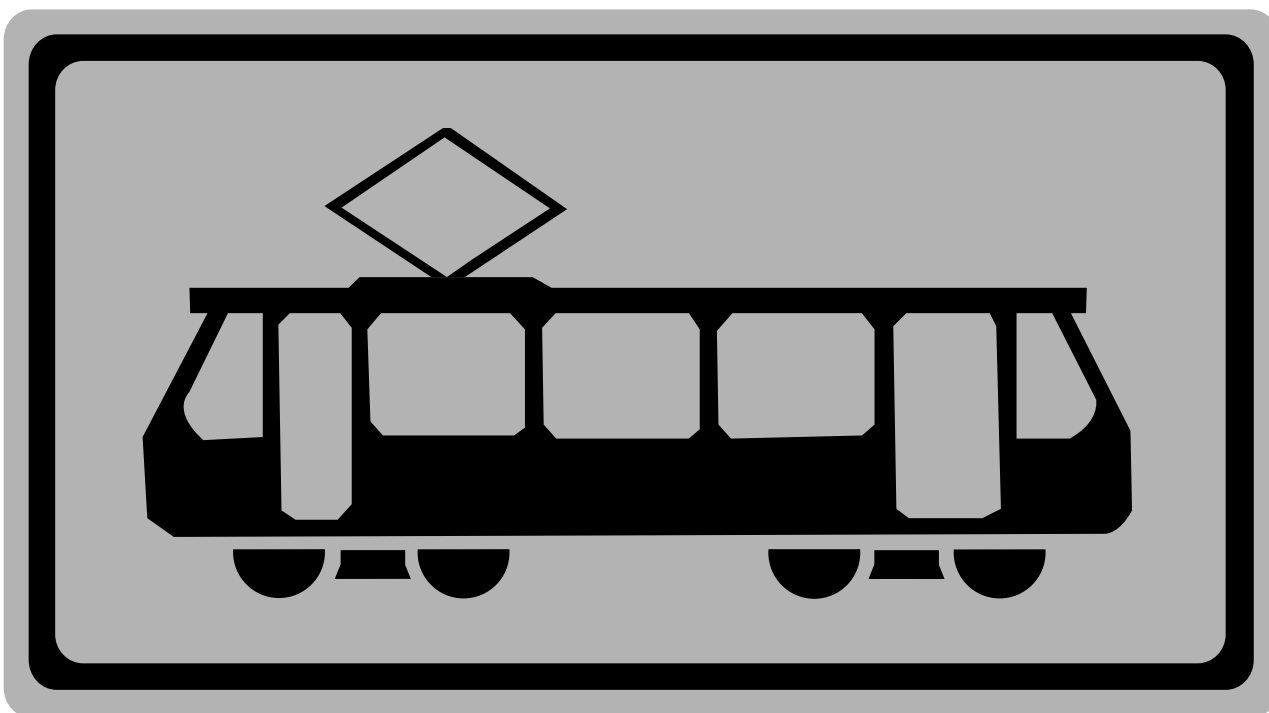

Abbiegen bei Rot erlaubt

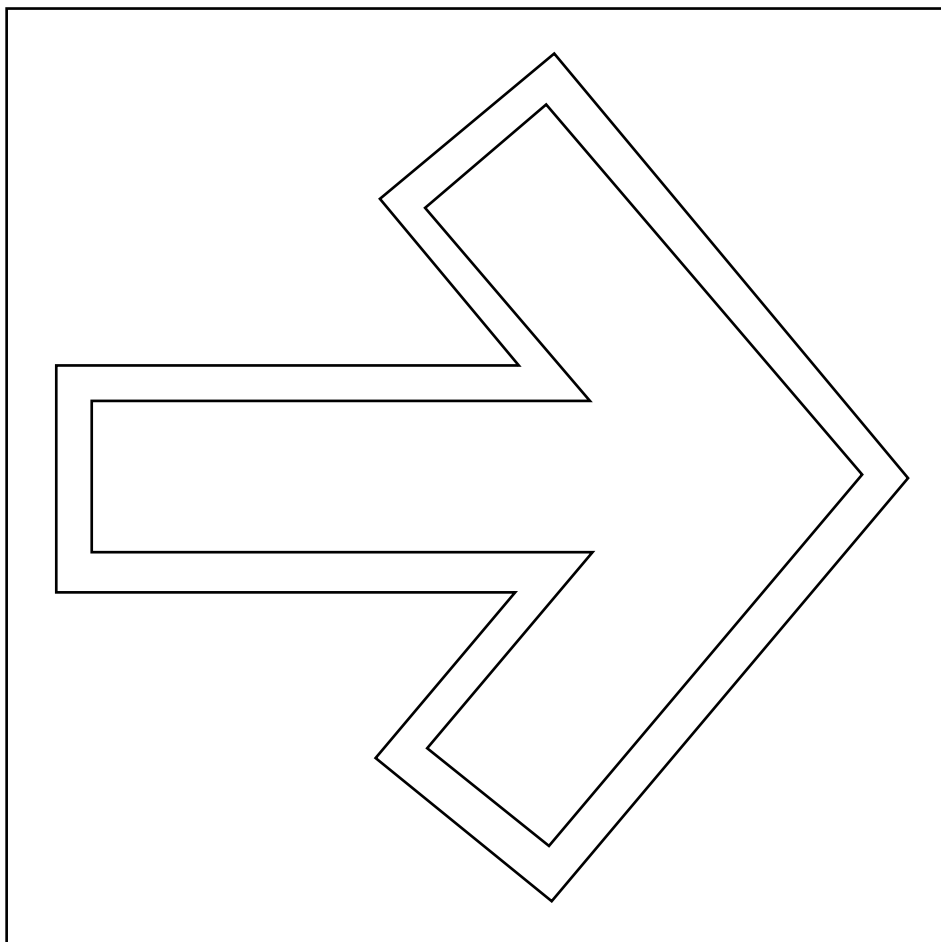
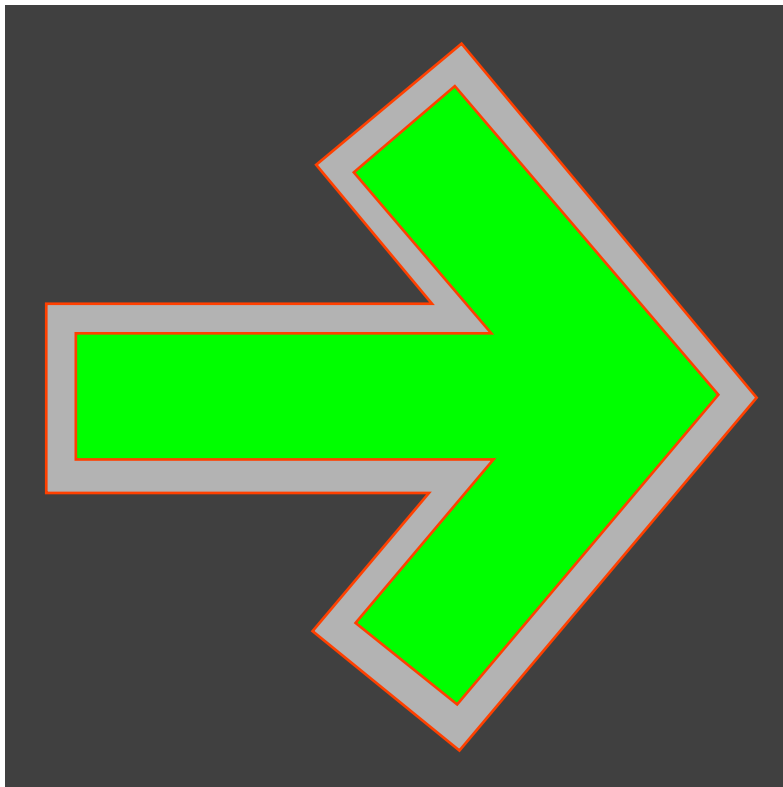

Durchfahrt verboten

